

# **Network Keyboard**

**User Manual**

## Preventive and Cautionary Tips

Before connecting and operating your keyboard, please be advised of the following tips:

- Ensure unit is placed in a well-ventilated, dust-free environment.
- Keep all liquids away from the keyboard.
- Please check the power supply to avoid the damage caused by voltage mismatch.
- Please make sure the keyboard work in the allowed range of temperature and humidity.
- Please keep the device horizontal and avoid the installation under severe vibration environment.
- The dust board will cause a short circuit after damping; please use brush to dedust regularly for the board, connector, chassis fan, etc.

# Table of Contents

Chapter 1 Introduction.....	6
1.1 Overview .....	6
1.2 Features .....	6
1.3 Appearance.....	8
Chapter 2 Operation Guide .....	9
2.1 User Account.....	9
2.2 Indicators & Buttons .....	9
2.3 Button Operation.....	12
2.3.1 Operating Video Wall Display.....	12
2.3.2 PTZ Control Buttons .....	12
2.3.3 Other Buttons .....	13
2.4 Input Method Shift .....	14
2.5 Basic Operation Procedure.....	14
2.6 Quick Configuration Guide.....	15
2.7 Quick Operation.....	17
Chapter 3 Local Keyboard Configuration by Admin .....	19
3.1 Login.....	19
3.2 Keyboard Management .....	19
3.2.1 Viewing Version Information .....	19
3.2.2 Configuring Network Settings .....	20
3.2.3 Configuring Hardware Settings.....	20
3.2.4 Configuring Time Settings .....	21
3.2.5 Selecting Language .....	21
3.2.6 Calibrating Screen.....	22
3.2.7 Upgrading Device .....	22
3.3 Device Management .....	23
3.3.1 Adding a Device.....	23
3.3.2 Editing/Deleting Device.....	24
3.4 User Management .....	25
3.4.1 Adding an User.....	25
3.4.2 Setting the Related Device .....	26
3.4.3 Editing User Password/Deleting User.....	27
3.4.4 Importing/Exporting Configuration File .....	27
3.5 Default.....	28
3.6 Logout.....	29
3.7 Reboot.....	29
3.8 Shutdown .....	29
Chapter 4 Local Keyboard Configuration by Operator .....	30
4.1 Encoder Settings .....	30
4.1.1 Network Settings.....	31
4.1.2 Serial Port Settings.....	31
4.1.3 Camera Settings .....	32

4.1.4 Alarm Settings.....	39
4.1.5 Exceptions.....	40
4.1.6 Maintenance.....	41
4.1.7 Stream Media Settings.....	41
4.2 Decoder Settings.....	42
4.2.1 Network Settings.....	42
4.2.2 Serial Port Settings.....	43
4.2.3 Output Settings.....	43
4.2.4 Video Wall.....	44
4.2.5 Decoding Status.....	44
4.2.6 Maintenance.....	45
4.3 Input Settings.....	45
4.3.1 Starting Local Live View.....	46
4.3.2 Live View by Channel-zero.....	46
4.3.3 Editing a Camera.....	47
4.3.4 Setting Input Group.....	47
4.4 Output Settings.....	48
4.4.1 Playback on Monitor.....	48
4.4.2 Editing an Output Channel.....	49
4.4.3 Setting Output Group.....	50
4.4.4 Setting Video Wall / Scene.....	50
4.5 Macro Settings.....	51
4.6 Playback.....	52
4.6.1 Playback by USB File.....	53
4.6.2 Playback by File.....	53
4.6.3 Playback by Time.....	54
4.7 Advanced Settings.....	55
4.7.1 Password Settings.....	55
4.7.2 AUX Key Settings.....	55
4.7.3 Live View & PTZ Speed Settings.....	56
4.7.4 FTP Settings.....	56
4.8 Logout.....	57
4.9 Reboot.....	57
4.10 Shutdown.....	57
Chapter 5 Keyboard Operation.....	58
5.1 Shortcut Operation.....	58
5.2 Local Live View.....	58
5.3 Display of Decoded Video on Monitor.....	59
5.3.1 Setting Multi-division Display.....	59
5.3.2 Setting Camera to Monitor.....	60
5.3.3 Setting Camera Group to Monitor.....	60
5.3.4 Setting Camera Group to Window.....	61
5.3.5 Setting Camera Group to Monitor Group.....	62
5.3.6 Setting a Tour.....	62

5.3.7 Calling a Tour.....	63
5.3.8 Setting a Group Tour.....	63
5.3.9 Calling a Group Tour.....	64
5.3.10 Operating Instant Playback .....	64
5.3.11 Operating Image Switch.....	65
5.4 PTZ Control .....	66
5.4.1 PTZ Control Function .....	66
5.4.2 Setting a Preset.....	66
5.4.3 Calling a Preset .....	67
5.4.4 Setting a Patrol .....	68
5.4.5 Calling a Patrol.....	69
5.4.6 Setting a Pattern .....	70
5.4.7 Calling a Pattern.....	71
5.4.8 Calling Pan Scan .....	72
5.5 Aux Functions .....	73
5.5.1 Two-way Audio.....	73
5.5.2 Picture Capture.....	73
5.5.3 Recording .....	74
5.5.4 Other Functions.....	74
Chapter 6 Server Operation .....	75
6.1 Control of MVC.....	75
6.1.1 Login .....	75
6.1.2 Device List .....	75
6.1.3 Camera List.....	77
6.1.4 Monitor List .....	78
6.1.5 Scene Settings .....	80
6.1.6 Screen Settings.....	82
6.2 Control of Analog Matrix.....	85
6.2.1 Login .....	85
6.2.2 Configuring RS-232 Parameters .....	85
6.2.3 Operating Analog Matrix .....	86
6.2.4 Configuring RS-485 Parameters .....	86
6.2.5 Operating PTZ Control .....	87
6.3 Access by iVMS Platform.....	89
6.3.1 Logging in to the iVMS Platform .....	89
6.3.2 Managing Output Channel .....	90
6.3.3 Managing Input Channel.....	91
6.3.4 Local Live View.....	92
6.3.5 Displaying Video on Monitor.....	92
6.3.6 Playback.....	93
Chapter 7 Keyboard Configuration by WEB Server .....	94
7.1 Configuring by <i>Admin</i> .....	94
7.1.1 Login .....	94
7.1.2 Keyboard Management .....	94

7.1.3 User Management .....	95
7.1.4 Device Management.....	97
7.1.5 Maintenance .....	98
7.2 Configuring by <i>Operator</i> .....	99
7.2.1 Device List .....	99
7.2.2 Input Settings .....	100
7.2.3 Output List .....	102
7.2.4 AUX Functions .....	103
7.2.5 Live View & PTZ Speed Settings .....	103
7.2.6 FTP Server Settings.....	103
Chapter 8 Keyboard Configuration Tool .....	105
8.1 System Requirements.....	105
8.2 Features .....	105
8.3 Selecting Login Mode to Configuration Tool .....	105
8.3.1 Login by Local Configuration File.....	106
8.3.2 Export/Login by Remote Configuration File .....	106
8.3.3 Remote Upgrade.....	107
8.4 Configuring Keyboard by Configuration Tool.....	108
8.4.1 Managing Device List.....	108
8.4.2 Managing User List.....	110
8.4.3 Managing Channel List .....	114
8.4.4 Importing Configuration File .....	117
Appendix 1: Specifications .....	118
Appendix 2: Upgrade by FTP .....	119

# Chapter 1 Introduction

## 1.1 Overview

HBK-1100KI Network Keyboard can be used to control the camera/speed dome, display of decoded video on video wall, control of matrix, as well as support 1 channel of video view at up to 1080P resolution. Designed with touch screen, it is easy to operate and configure settings.

## 1.2 Features

### Hardware

- 7" TFT touch screen at 800×480 resolution;
- 4-axis joystick;
- Shortcut keys for dome control, setting and calling of preset, patrol and pattern;
- Shortcut keys for playback operation;
- Shortcut keys for input group and output group;
- Shortcut keys for wiper and light control operation.

### Software

- Administrator and operator user management;
- Support upgrade by U-flash disk;
- Auto searching connected devices in the same network area;
- Support 3 operators, and each user is allowed to operate 1280 devices;
- Import and export of keyboard configuration parameters;
- Macro command operation;
- Storage of record files and captured pictures to U-flash disk or FTP server;
- Play back record files from the U-flash disk;
- Play back the remote record files by time or by file;
- Two-way audio;
- Support configuration by WEB server;
- Support configuration by the Keyboard Configuration Tool;
- Configuration and control of the MVC system;
- Support control of the analog matrix with the protocol of ZT-1.0, ZT-2.0, EXTRON or CREATOR;
- Control of up to 255 analog domes by RS-485 connection;
- Accessible by the platform software.

### Decoding Capability

- Provide 1-ch video decoding and local decoding;
- Support standard MPEG4, private H.264 and standard H.264 encoding formats;
- Decoding at up to 1080P resolution.

### Display of Decoded Video on Monitor

- Display of decoded camera on selected window;

- Display of decoded camera group on selected window;
- Sequence display of decoded camera group on monitor;
- Sequence display of decoded camera group on monitor group;
- Display of video via MVC on video wall.



## 1.3 Appearance

Front View:

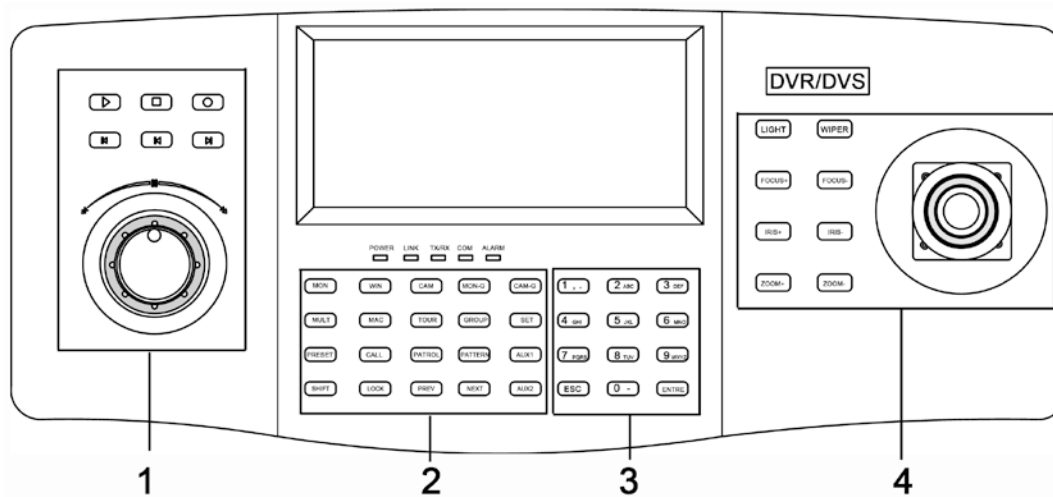

Description of panel:

Serial No.	Description	Serial No.	Description
1	Record playback	2	Functional buttons
3	Numeric buttons	4	PTZ control area

Interface Description:

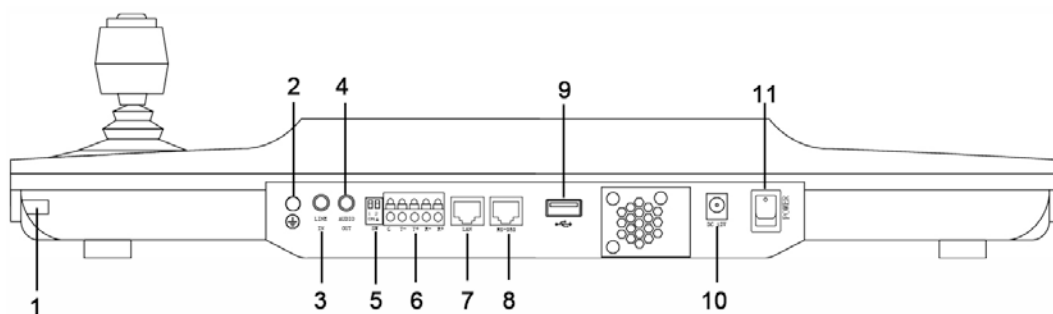

Serial No.	Description	Serial No.	Description
1	Touch pen	2	GND
3	Line In	4	Audio Out
5	Reserved	6	RS-485 Interface
7	LAN	8	RS-232 Interface
9	USB Interface	10	12 VDC Power Supply
11	Power On/Off		

## Chapter 2 Operation Guide

### 2.1 User Account

The keyboard user account is classified to two types: the **admin** and the **operator**.

The **admin** user is authorized with the following operation permissions:

1. Add a maximum of 3 operators;
2. Configure the keyboard parameters;
3. Add, edit and delete device;
4. Add, edit and delete user, as well as assign device for the user;

The **operator** user is allowed to operate the assigned device only;

Up to 1280 devices can be assigned for each operator.

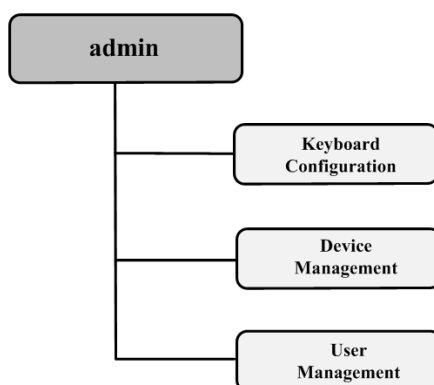

### 2.2 Indicators & Buttons

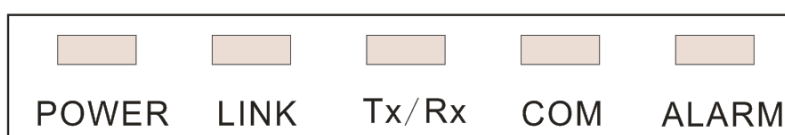

LED Indicators on Panel:

LED Indicator	Description
POWER	Normally lights when the keyboard is powered on.
LINK	Lights when the keyboard is connected with the network.
Tx/Rx	Flickers when the keyboard is transmitting/receiving data.
COM	Reserved
ALARM	Reserved

**Functional Buttons:**

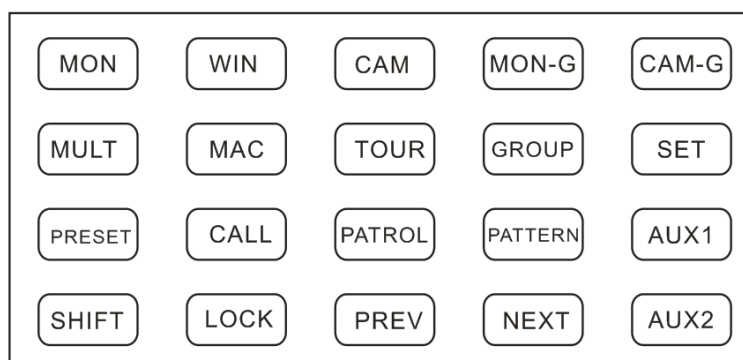

MON	WIN	CAM	MON-G	CAM-G
Select monitor	Select window	Select camera	Select monitor group	Select camera group
MULT	MAC	TOUR	GROUP	SET
Multi-division	Call	Set or call tour	Set or call group	Set mode
PRESET	CALL	PATROL	PATTERN	AUX1
Set preset	Call preset	Set or call patrol	Set or call pattern	AUX 1
SHIFT	LOCK	PREV	NEXT	AUX2
Shift	Lock screen	Previous camera	Next camera	AUX2

**LOCK Button:**

The *LOCK* button on the keyboard is used to lock the keyboard and mouse operation. After being locked, it is unallowable to operate all keys (except *LOCK* and *SHIFT*), joystick, mouse and the touch screen.

In the any interface or operation status, you can press and hold the *LOCK* key or press the *SHIFT + LOCK* keys to lock the keyboard operation.

In the lock status, you can press and hold the *LOCK* key or press the *SHIFT + LOCK* keys to unlock the keyboard operation.

**Note:** The keys will be locked as well when the screen is automatically locked.

**Numeric Buttons:**

The numeric buttons are used to input numerals.

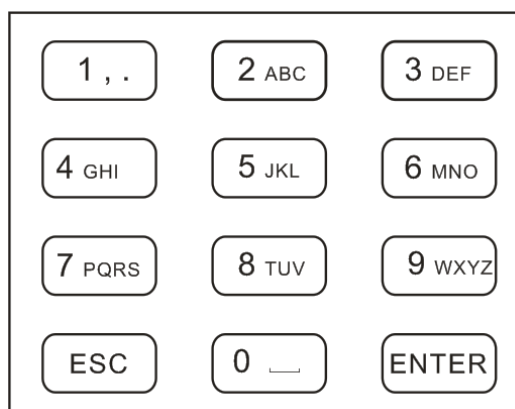

**4-axis Joystick:**

Use the joystick to realize pan and tilt movement at 8 directions.

The 4-axis joystick can be used to control the zoom; and the central button used as Enter button and to realize picture capture as well.

**Note:** The captured pictures can be saved in U-flash disk or uploaded to the FTP server.

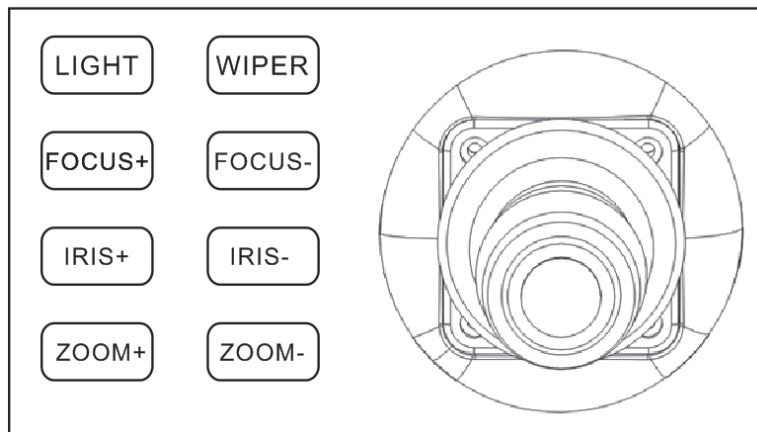



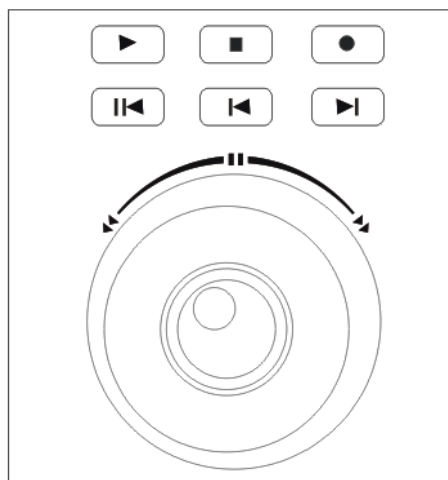

**Playback Control:**

Rotate the outer ring of shutter in clockwise direction to increase speed, and up to 16X playing speed can be achieved. Rotate the outer ring of shutter in anti-clockwise direction to decrease speed, and 1/16X playing speed can be achieved.

In playback by file, rotate the inner ring of shutter to play the previous/next file.

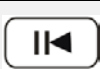

	Backward 5min		Stop		Record
	Play/Pause		Previous File		Next File

## 2.3 Button Operation

### 2.3.1 Operating Video Wall Display

Button	Description	Example
<b>MON</b>	<i>Num+MON</i> : select the video output channel to be displayed on the video wall. <b>Note:</b> When the Num=0, the system enters the local live view mode.	Press the <i>2+MON</i> buttons to select the monitor 2.
<b>MULT</b>	<i>Num+MULT</i> : select different multi-division display modes for the selected output channel.	Press the <i>2+MON+4+MULT</i> buttons to configure 4-division display for the monitor 2.
<b>WIN</b>	<i>Num+MON+Num+WIN+Num+CAM</i> : the video signal from the camera group can be outputted to and displayed on the selected window of monitor in cycle.	Press the <i>2+MON+3+WIN</i> buttons to select the window 3 of the monitor 2.
<b>CAM</b>	<i>Num+CAM</i> : select the video input.	Press the <i>2+MON+3+WIN+5+CAM</i> buttons to display the video input 5 on the window 3 of monitor 2.
<b>MON-G</b>	<i>Num+MON-G</i> : select the monitor group.	Press the <i>1+MON-G</i> buttons to select the monitor group 1.
<b>CAM-G</b>	<i>Num+CAM-G</i> : select the camera group.	Press the <i>1+MON+1+CAM-G</i> buttons to select the camera group 1 to be displayed on the monitor 1.
<b>SET</b>	<i>SET+Num+TOUR/GROUP/PATROL/PATTERN</i> : set the tour, group, patrol and pattern.	Press the <i>SET+1+PATTERN</i> buttons to set the pattern 1.
<b>TOUR</b>	<i>SET+Num+TOUR</i> : set the tour. <i>Num+TOUR</i> : call the defined tour.	Press the <i>SET+1+TOUR</i> buttons to set the tour 1. Press the <i>1+TOUR</i> buttons to call the pre-defined tour 1.
<b>GROUP</b>	<i>SET+Num+GROUP</i> : set the group. <i>Num+GROUP</i> : call the defined group.	Press the <i>SET+1+GROUP</i> buttons to set the group 1. Press the <i>1+GROUP</i> buttons to call the defined group 1.

### 2.3.2 PTZ Control Buttons

Button	Description	Example
<b>PRESET</b>	<i>Num+PRESET</i> : move the pan/tilt/zoom to the desired position, and then press the <i>Num+PRESET</i> buttons to set the preset.	Press the <i>1+PRESET</i> buttons to set the preset 1.
<b>CALL</b>	<i>Num+CALL</i> : call the defined preset.	Press the <i>1+CALL</i> buttons to call the preset 1.
<b>PATROL</b>	<i>SET+Num+PATROL</i> : set the patrol. <i>Num+PATROL</i> : set the defined patrol.	Press the <i>SET+1+PATROL</i> buttons to set the patrol 1. Press the <i>1+PATROL</i> buttons to call the patrol 1.
<b>PATTERN</b>	<i>Num+PATTERN</i> :	Press the <i>SET+1+PATTERN</i> buttons to set the pattern 1. Press the <i>1+PATTERN</i> buttons to call the pattern 1.

### 2.3.3 Other Buttons

Button	Description	Example
<b>MAC</b>	<i>Num+MAC</i> : call the MAC command.	Press the <i>1+MAC</i> buttons to call the MAC command 1.
<b>SHIFT</b>	<i>SHIFT+LOCK</i> : lock/unlock the system.	Press the <i>SHIFT+LOCK</i> buttons to lock/unlock the system.
<b>LOCK</b>	Lock/unlock the system.	Press and hold the <i>LOCK</i> button or press the <i>SHIFT+LOCK</i> buttons to lock/unlock the system.
<b>PREV</b>	Select the previous camera for live view on keyboard or on TV wall.	
<b>NEXT</b>	Select the next camera for live view on keyboard or on TV wall.	
<b>AUX1</b>	Press the AUX1 button to realize its defined function (two-way audio, picture capture or vide wall/scene switch).	
<b>AUX2</b>	Press the AUX2 button to realize its defined function (two-way audio, picture capture or vide wall/scene switch).	

## 2.4 Input Method Shift

Click the tab **abc** on the soft keyboard to enter the interface for inputting the English letters, and the **a** can be used to switch the uppercase/lowercase.



Click the tab **123** on the soft keyboard to enter the interface for inputting the numerals.



## 2.5 Basic Operation Procedure

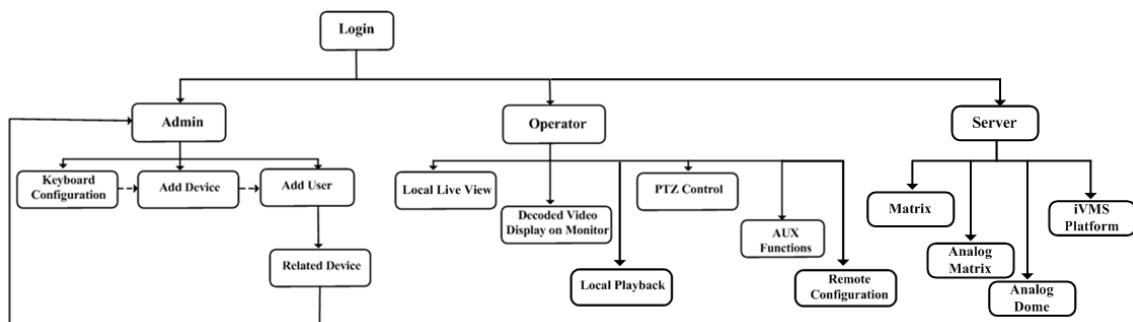

**Admin:** For the first time to operate the keyboard, you should configure the keyboard parameters in Keyboard Configuration menu, add device and operator, and then link the added device to assigned operator.

**Operator:** The operator is allowed to operate local live view, remote configuration of encoder/decoder parameters, display of decoded video on monitor, local playback, PTZ control, AUX functions, etc.

**Server:** Control the matrix system, analog matrix, analog dome and iVMS platform.

## 2.6 Quick Configuration Guide

### Steps:

1. When the keyboard has started up, it enters the following interface:
2. For basic keyboard operation, select the **Keyboard** icon to continue and enter the login interface.

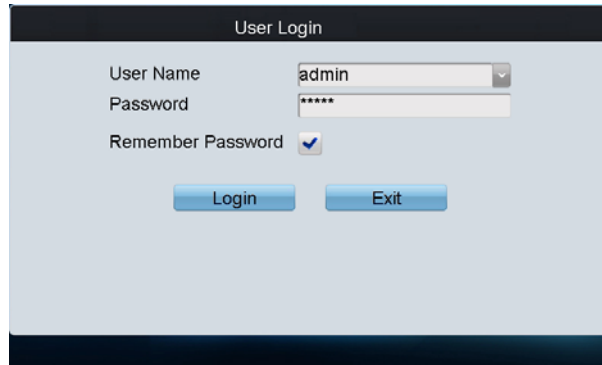

The screenshot shows the 'User Login' interface. It features a title bar 'User Login' and a light blue background. There are three input fields: 'User Name' with a dropdown menu showing 'admin', 'Password' with masked characters '\*\*\*\*\*', and 'Remember Password' with a checked checkbox. At the bottom, there are two blue buttons labeled 'Login' and 'Exit'.

3. Select **admin** on the login interface and then input the admin password (default: 12345) to enter the admin interface of keyboard operation.
4. Click **Keyboard > Network** to enter the Network Settings interface. Configure the network settings of the keyboard, including the **Port**, **IP address**, **Subnet Mask**, **Default Gateway**, **Preferred DNS** and **Alternate DNS**. Click **Apply** to save the settings.



The screenshot shows the 'Keyboard -- Network Settings' interface. It has a title bar and a sidebar on the left with menu items: Version, Network (highlighted), Hardware, Time, Language, Calibration, and Upgrade. The main area contains several settings: DHCP (checkbox), Port (8000), IP Address (172.6.23.190), Subnet Mask (255.255.255.0), Default Gateway (172.6.23.1), Preferred DNS Server, Alternate DNS Server, and MAC Address (00:40:30:11:11:fd). There are 'Apply', 'Logout', and 'Return' buttons.

5. Click **Return** to back to the main interface.
6. Click **Device** on the **admin** main interface to enter the device management menu.
7. Click **Add Device** to enter the **Device-Add Device** interface. Input the device name, device IP/domain name, port, user name and password, and then click **Add** to add the device.



The screenshot shows the 'Device -- Add Device' interface. It has a title bar and contains five input fields: 'Device Name', 'IP/Domain', 'Port' (with '8000' entered), 'User Name' (with 'admin' entered), and 'Password'. At the bottom, there are two blue buttons labeled 'Add' and 'Cancel'.

8. Return to the **Device-Device List** interface, and the successfully added device is shown on the list. Click **Return**



to back to the main interface.



- Click **User** on the main interface to enter the **User-User List** interface.

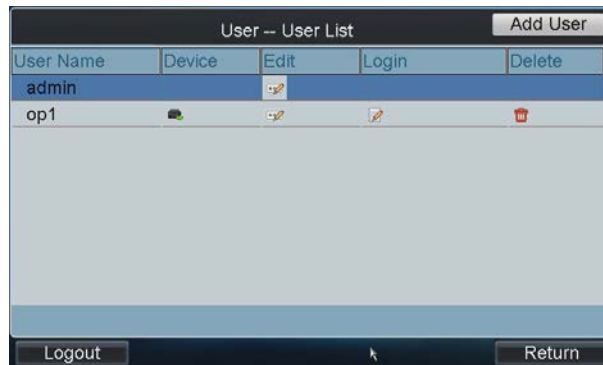

- In the User List interface, click **Add User** to enter the **Add User** interface. Input the user name, password and verify the password. Finally, click **Add** to finish the adding of user.



- Return to the User List interface, and click  of the selected user to enter the **User-Device** interface.

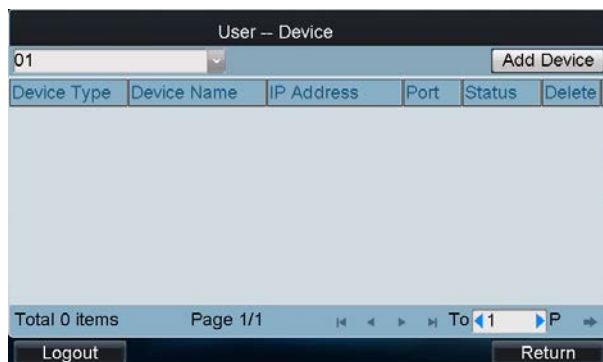

- Click **Add Device** to enter the **User-Add Device** interface. Select the device by clicking the checkbox, and click **Add** to add the device for the current user.

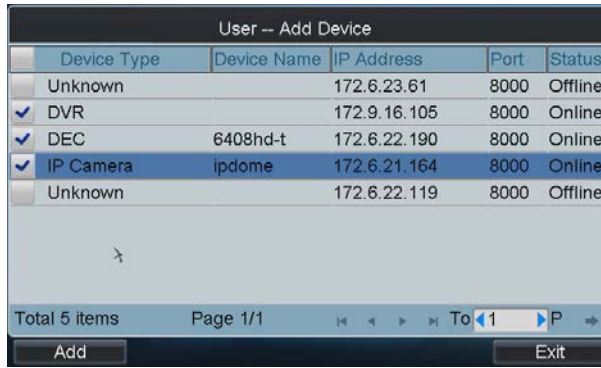

13. The added device (s) for the current user can be displayed on the **User List** interface.

14. You can directly click the  (Login) icon of a user to switch its operating interface.

Or you can click **Logout** on the **admin** main interface, the message box “Logout Now?” will pop up. Click **Yes** to confirm the logout, or **No** to cancel the operation.



## 2.7 Quick Operation

### Multi-division Display

The *Operator* user is allowed to select different multi-division display modes for the selected output channel. Currently, 1/4/9/16-division display modes are configurable.

#### Steps:

1. Press the *Num + MON* keys to select the monitor.
2. Press the *Num + MULT* keys to select the multi-division display mode for the output channel.



### Display of Decoded Video on Monitor

#### Steps:

1. Press the *Num + MON* keys to select the monitor.

2. Press the *Num + WIN* keys to select the display window on the monitor.

You can also directly touch the screen to select the display window.

3. Press the *Num + CAM* keys to select the input camera.

Example: You can press the "1+MON, 2+WIN, 3+CAM" keys to decode the video signal from camera 3 and display it on window 2 of monitor 1.



# Chapter 3 Local Keyboard Configuration by Admin

You can configure the keyboard by locally, WEB page or by the configuration tool. This chapter introduces the local keyboard configuration.

## 3.1 Login

**Steps:**

1. Click the **Keyboard** icon on the startup interface.
2. Select **admin** on the login interface and then input the admin password (default: 12345).
3. You can check the checkbox of **Remember Password** to save the login password for future use.
4. Click **Login** to enter the main interface of *admin*.



## 3.2 Keyboard Management

On the main interface of *admin*, click the **Keyboard** on the left navigation bar to enter the Keyboard Management interface. In the Keyboard Management interface, you can view the device version information, configure network parameters, configure hardware settings, adjust time, select language, screen calibration and upgrade system.

### 3.2.1 Viewing Version Information

Click **Version** to enter the **Keyboard-Version** interface to view the current version information of the keyboard.



### 3.2.2 Configuring Network Settings

Configure the network settings of the keyboard, including the **Port**, **IP address**, **Subnet Mask**, **Default Gateway**, **Preferred DNS** and **Alternate DNS**. Click **Apply** to save the settings.

**Note:** Make sure the DHCP is supported by the router before enabling the function.

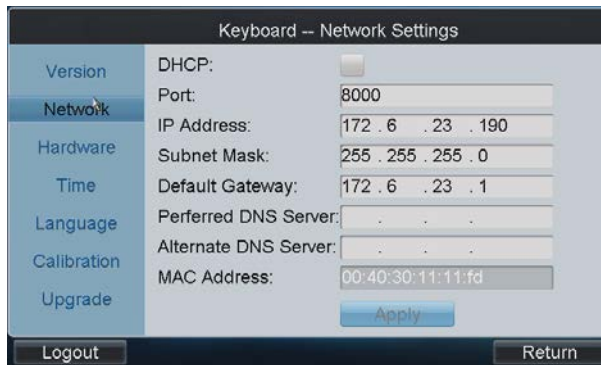

### 3.2.3 Configuring Hardware Settings

**Sound Effect/Alarm Sound/Key Light:** Click the corresponding checkbox to  to enable the function, or remain it as  to disable the function.

**Keyboard Lock Delay, Screen Off Delay:** Use the  or  to decrease or increase the key lock timeout and the screen-close timeout, with the range of 0~10 minute (s) configurable. When the value is set to 0, the key and screen will be unlocked.

**Background Contrast:** Click  to select the value from the drop-down menu, with the 3: 1, 1: 1, 1: 3 and *non-transparent* optional.

**Note:** The Background Contrast refers to the contrast of the local decoded video and menu, and is valid only for the local live view.

**Mouse Speed:** Select the mouse speed to level 0~3.

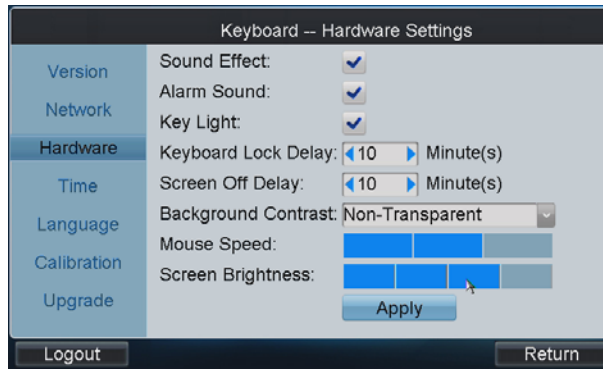

**Screen Brightness:** Select the screen brightness to level 0~4.

Click **Apply** to save the settings.



### 3.2.4 Configuring Time Settings

**Date:** Click  to select the date from the calendar.

**Time:** Click  or  to decrease or increase the time value.

Click **Apply** to save the settings.

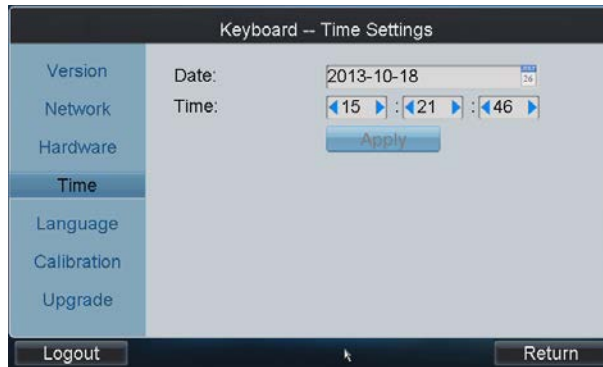

### 3.2.5 Selecting Language

**Language:** Click  to select English as the system language.

Click **Apply** to save the setting.



### 3.2.6 Calibrating Screen

In order to use the touch screen correctly, it needs to calibrate the screen positioning properly.

**Steps:**

1. Click **Calibration** to start the calibration of touch screen positioning.
2. The system will pop up the Hint message box. Click **Yes** to continue the calibration.

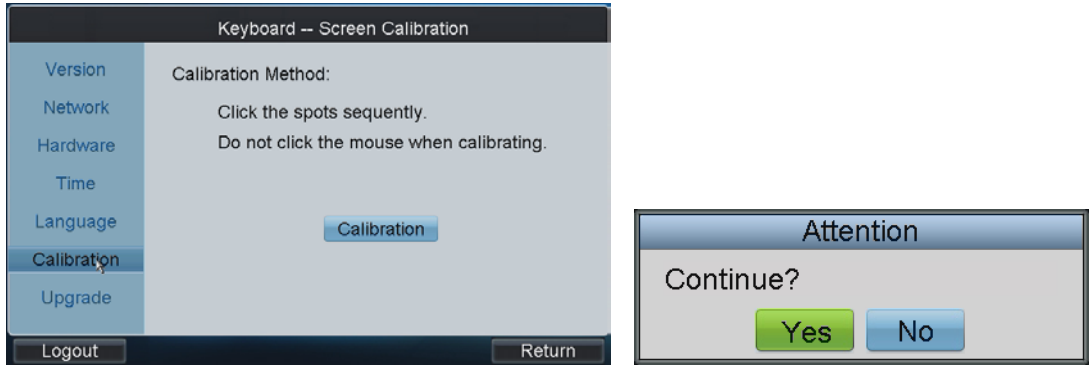

3. Use the touch pen to click the three spots marked as "+" by following the hints.
4. The system will pop up the hint "Screen Calibration completed", click **OK** to finish the operation.



### 3.2.7 Upgrading Device

**Upgrade by FTP**

1. Input the address of the FTP server and then click **FTP Upgrade** to operate the upgrade.

**Note:** You must create the FTP server connection first by TFTP or WFTP in PC before operating the FTP upgrade.

Please refer to *Appendix2* for the upgrading.



2. If the upgrading is failed, the corresponding error message box will pop up.



**Note:** When the upgrading is successful, the keyboard will restart automatically to complete the upgrade.

### Upgrade by USB-flash Disk

**Steps:**

1. Insert the U flash disk to the USB interface and then click **USB Upgrade** to enter the USB upgrade interface.
2. Select the upgrade file from the disk and finally click **Upgrade** to start upgrading.

**Note:** The upgrade file must be *digicap.dav*.

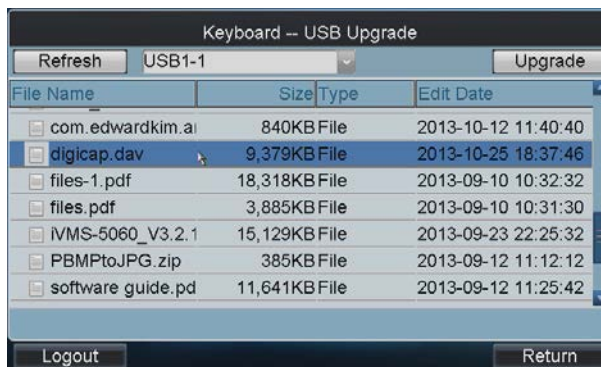

3. If the upgrading is failed, the corresponding error message box will pop up.

**Note:** When the upgrading is successful, the keyboard will restart automatically to complete the upgrade.

## 3.3 Device Management

Click **Device** on the **admin** main interface to enter the **Device-Device List** interface.



### 3.3.1 Adding a Device

**Task1: Add Device by Auto Searching**

**Steps:**



1. Click **Auto Search** button at the upper left corner to enter the **Device-Auto Search** interface.

**Note:** Only the device that is in the same network segment with the keyboard can be searched out by the keyboard.

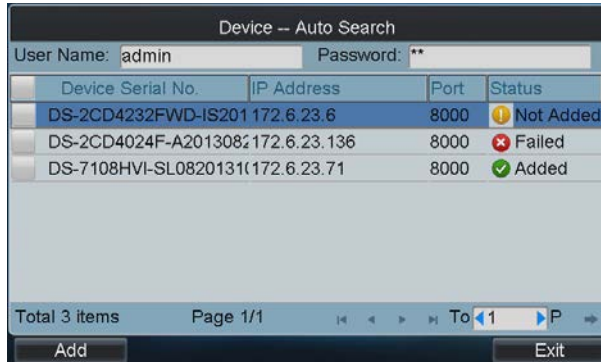

2. After the searching is completed, all devices searched out and their information will be displayed in the list below. Select the device from the list, and then input the login user name and password.

3. Click **Add** to add it to the system.

**Note:** You can also select multiple devices to be added at a time if they have the same login user name and password by checking the checkboxes in front of them.

**Status:** In the status bar, the icon indicates the device is not added, indicates the device is failed to be added, and the indicates the device is successfully added.

4. After having added the devices, click **Exit** to return to the **Device-Device List** interface, where you can view the information of added devices.

**Task2: Add Device by Manually**

**Add Device:** Click **Add Device** to enter the **Add Device** interface. Input the device name, device IP, port, user name and password, and then click **Add** to add the device.

If the input message is incorrect or the device is offline, the message box “Adding Device failed” will pop up.

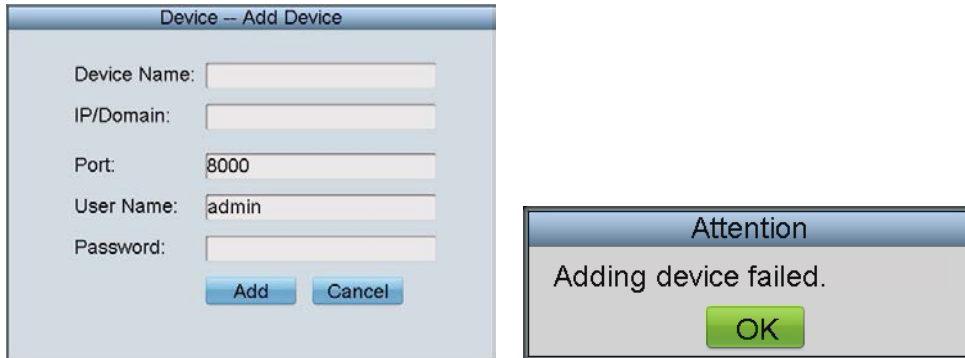

### 3.3.2 Editing/Deleting Device

**Edit Device**

On the **Device-Device List** interface, click of the device from the list to be edited and enter the **Device-Edit Device** interface. You are allowed to edit the device name, port, user name and password. Finally, click **Edit** to edit the device information.

**Note:** The user name and password here refer to that are used for to log in the device from keyboard.

### Delete Device

On the **Device-Device List** interface, select the device from the list to be deleted, and click **Delete** to delete it. In the pop-up message box, click **Yes** to finish the deletion.

## 3.4 User Management

Click **User** on the **admin** main interface to enter the **User-User List** interface.

User Name	Device	Edit	Login	Delete
admin				
op1				

### 3.4.1 Adding an User

**Steps:**

1. Click **Add User** to enter the **User-User List** interface.

2. Input the user name, password and verify the password.
3. Click **Add** to finish the adding of user.

### 3.4.2 Setting the Related Device

**Purpose:**

To the added operators, they do not have the permission of adding devices. Perform the following procedures to relate devices to the operators.

**Steps:**

1. In the **User-User List** interface, click  to enter the **User-Device** interface.

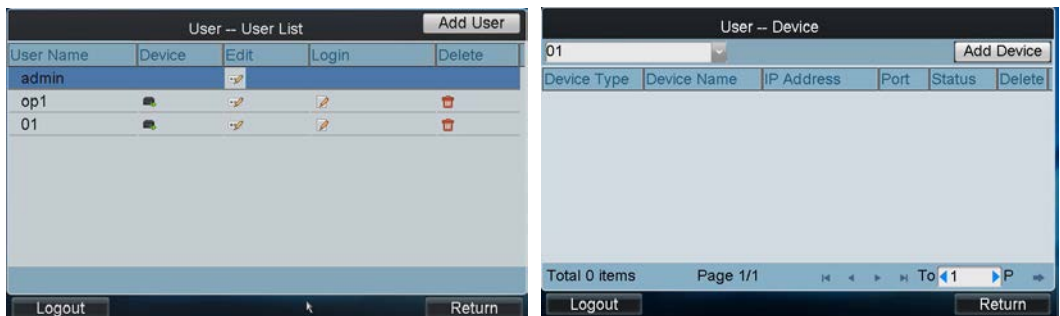

2. Click **Add Device** to enter the **User-Add Device** interface. Select the device by clicking the checkbox, and click **Add** to add the device for the current user.

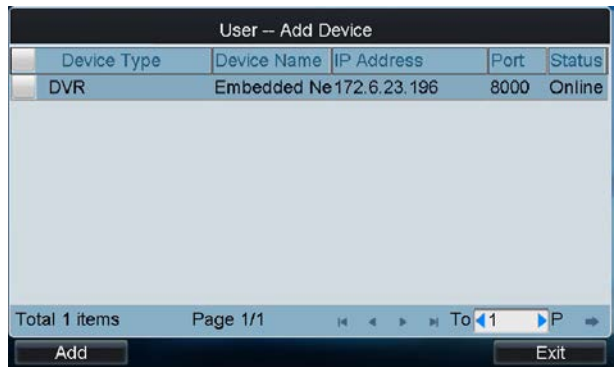

3. The successfully added device is listed on the **User-Device** interface.

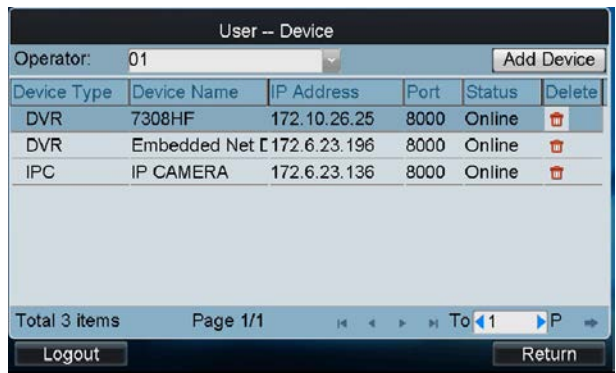

4. After having configured the above settings, click **Logout** on the admin main interface, the message box "Logout Now?" will pop up. Click **Yes** to confirm the logout, or **No** to cancel the operation.

**Deleting a Device**

Enter the **User-Device** interface, you can select the device from the list and click  to delete the related device for the current user. In the pop-up message box, click **Yes** to confirm the deletion.

**Operator User Login**

On the **User-User List** interface, you can click  (Login Operator) to directly switch to the *Operator* user login interface.

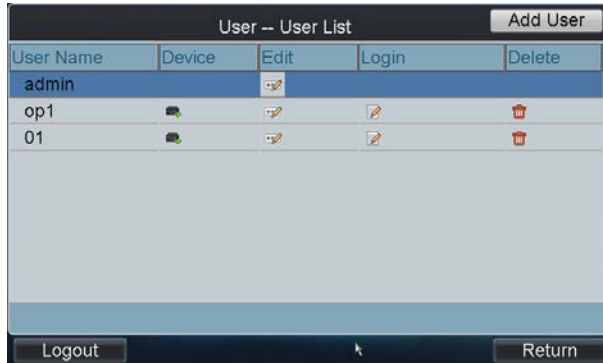

**3.4.3 Editing User Password/Deleting User**

**Edit User Password:** On the **User-User List** interface, you can click  to change of password of the selected user.



**Delete User:** Click  to delete the selected user.

**3.4.4 Importing/Exporting Configuration File**

**Purpose:**

The configuration files of the device can be exported to local device for backup; and the configuration files of one device can be imported to multiple device devices if they are to be configured with the same parameters.

Click **Config file** on the **admin** main interface to enter the file Export/Import Configuration interface.



### Importing Configuration File

1. Insert the U-flash disk to the USB interface on the keyboard.
2. Enter the disk to select a file.
3. Click **Import** to import the configuration file.

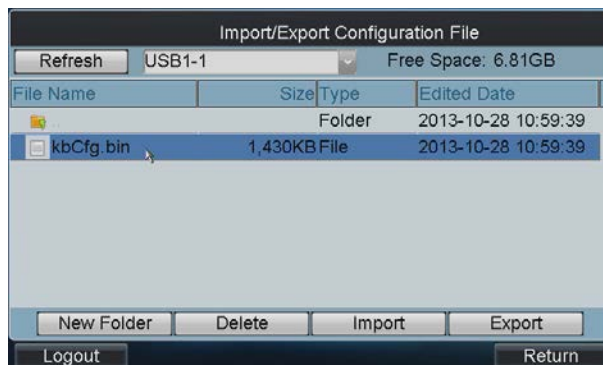

### Exporting Configuration File

1. Insert the U flash disk to the USB interface on the keyboard.
2. Click **Export** to export the configuration file named in *kbCfg.bin*.



If the imported configuration file is not correct, the message box "Importing file failed: file type mismatched" will pop up.

## 3.5 Default

### Purpose:

There are two types of restoring default supported: Simple and Complete.

- **Simple:** Remain the password of admin and network parameters, and restore other parameters to default.
- **Complete:** Restore all the parameters of the keyboard to default.

### Steps:

1. Click **Default** on the **admin** main interface. And select default type in the pop-up box.

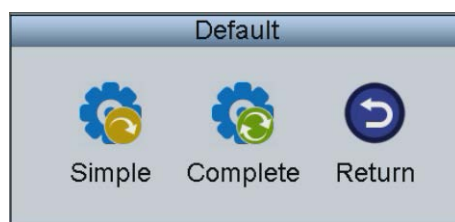

2. Click **Yes** to continue the operation, or **No** to cancel the operation.

## 3.6 Logout

Click **Logout** on the **admin** main interface, and the message box "Logout now?" pops up.

Click **Yes** to confirm the logout, or **No** to cancel the operation.

After logout, the system will return to the User Login interface.

## 3.7 Reboot

Click **Reboot** on the **admin** main interface, the message box "Reboot now?" will pop up.

Click **Yes** to confirm the reboot, or **No** to cancel the operation.

## 3.8 Shutdown

Click **Shutdown** on the **admin** main interface, the message box "Shut down now?" will pop up.

Click **Yes** to confirm the shutdown, or **No** to cancel the operation.

# Chapter 4 Local Keyboard Configuration by Operator

**Steps:**

1. On the **User Login** interface, select the user name (operator) and enter password.
2. If needed, check the checkbox of **Remember Password** to save the login password for future use.
3. Click **Login** to enter the **operator** main interface.



4. Enter the main interface.

Click the **Device List** on the main interface to enter the Device List interface.

The list will display all devices which can be controlled by the current login user.

Device List					
Device Type	Device Name	IP Address	Port	Status	Config
Unknown		172.6.23.61	8000	Offline	
Unknown		172.9.16.105	8000	Offline	
DEC	Embedded m	172.6.22.190	8000	Online	
IP Camera	ipdome	172.6.21.164	8000	Online	
Unknown		172.6.22.119	8000	Offline	

Total 5 items    Page 1/1    To 1/1    P

Logout    Return

## 4.1 Encoder Settings

Click of an encoder on the **Device List** interface and enter its remote settings interface. You can configure the settings for network, RS-232/RS-485 serial port, camera, alarm, exception, stream media, etc.

Device Type	Device Name	IP Address	Port	Status	Config
Unknown		172.6.23.61	8000	Offline	
Unknown		172.9.16.105	8000	Offline	
DEC	Embedded m	172.6.22.190	8000	Online	
IP Camera	ipdome	172.6.21.164	8000	Online	
Unknown		172.6.22.119	8000	Offline	

Total 5 items Page 1/1 To 1 P

Logout Return

### 4.1.1 Network Settings

Click **Network** on the remote settings interface to enter the **Network Settings** interface.

Network Settings	
Network	
Serial	General Settings <input type="button" value="Set"/>
Camera	PPPoE <input type="button" value="Set"/>
Alarm	DDNS <input type="button" value="Set"/>
Exception	NTP <input type="button" value="Set"/>
Maintenance	Network Disk <input type="button" value="Set"/>
Reboot	
Stream Media	

Logout Return

You can enter the following settings interface to configure the network parameters:

**General Settings:** Configure the NIC type, IP address, port, gateway, subnet mask, MAC address, DNS server address, and HTTP port of the current encoder device.

**PPPoE:** Configure the user name and password of PPPoE settings.

**DDNS:** Enable DDNS, select the protocol type to IP Server, DynDns, PeanutHull or NO-IP, and configure the corresponding settings.

**NTP:** Configure NTP settings to synchronize the time of device to the selected time zone.

**Network Disk:** Set the IP address, file path and type of the network disk to use.

### 4.1.2 Serial Port Settings

Click **Serial** on the remote settings interface to enter the **Serial Settings** interface.

Serial Port Settings	
Network	
Serial	
Camera	RS232 <input type="button" value="Set"/>
Alarm	
Exception	RS485 <input type="button" value="Set"/>
Maintenance	
Reboot	
Stream Media	

Logout Return



You can set the RS232 port and RS485 parameters.

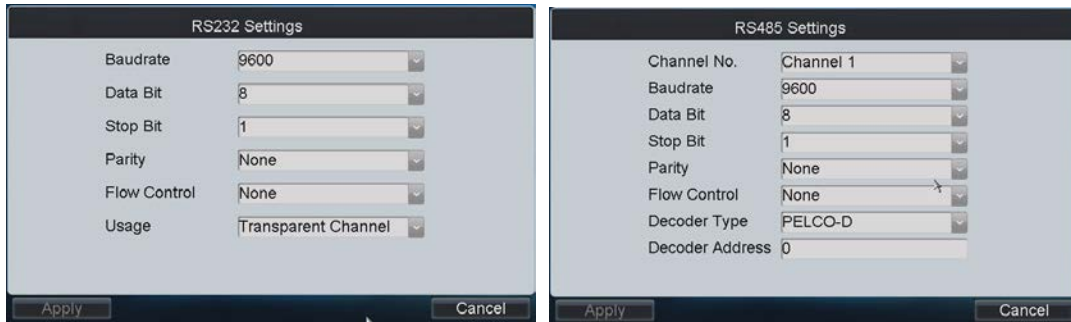

### 4.1.3 Camera Settings

Click **Camera** on the remote settings interface to enter the **Camera Settings** interface.

You can configure the video display, video parameters, record settings, motion detection, video loss detection, tampering alarm, privacy mask, and IPC management (for hybrid DVR and NVR only).

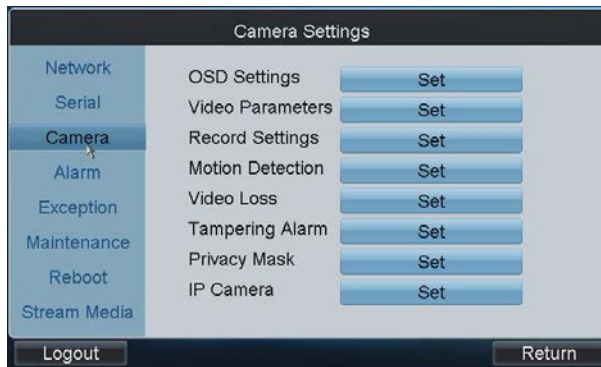

### Configuring Video Display

On the **Video Display** interface, you can select the camera name for configuration, edit the camera name, select display or not display of the name/date /week, set the date/time format and OSD display. You can also copy the current settings to other camera (s).



### Configuring Video Parameters

On the **Video Parameters** interface, you can select the camera name for configuration, set the main/sub stream, stream type, resolution, frame rate, bit rate type, Max. bit rate, and image quality. You can also copy the current

settings to other camera(s).

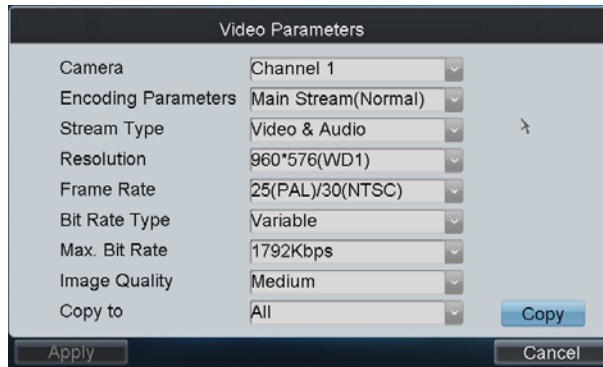

## Configuring Record Settings

### 1. Configuring Advanced Settings

On the **Record Settings** interface, select the camera for configuration. Click **Advanced** to enter the **Advanced Settings** interface where you can configure the pre-record, post-record, expired time, redundant record, record audio, etc.

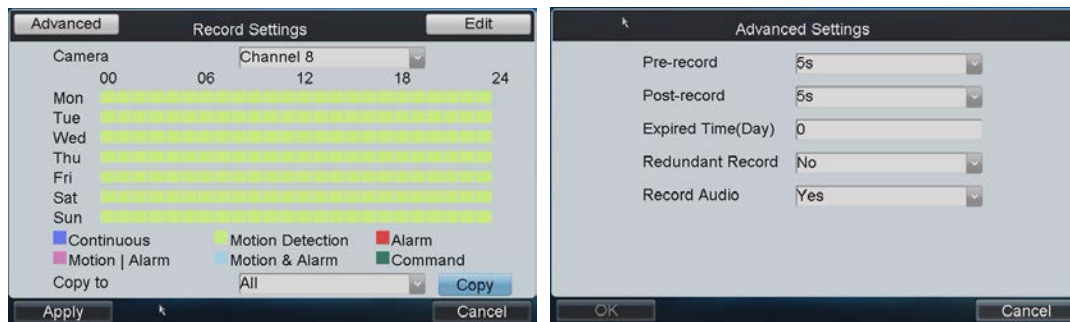

**Pre-record:** The time you set to record before the scheduled time or event. For example, when an alarm triggered the recording at 10:00, if you set the pre-record time as 5 seconds, the camera records it at 9:59:55.

**Post-record:** The time you set to record after the event or the scheduled time. For example, when an alarm triggered the recording ends at 11:00, if you set the post-record time as 5 seconds, it records till 11:00:05.

**Expired Time:** The expired time is the longest time for a record file to be kept in the HDD, if the deadline is reached, the file will be deleted. You can set the expired time to 0, and then the file will not be deleted. The actual keeping time for the file should be determined by the capacity of the HDD.

**Redundant Record:** Enabling redundant record or capture means you save the record and captured picture in the redundant HDD.

**Record Audio:** Choose “yes” to record the sound, “no” to record the image without sound.

### 2. Editing Recording Schedule

On the Record Settings interface, click **Edit** to enter record schedule setting interface.



**Steps:**

1. Click the checkbox of **Enable Schedule** item.
2. Select the day you want to set recording schedule. You can also select it to All Week.
3. To schedule an all-day recording, click the checkbox of the **All Day** item.
4. Select the recording type for the selected day to Continuous, Motion Detection, Alarm, Motion / Alarm or Motion & Alarm.
5. Configure the period for each day and select the recording type for the selected period.  
**Note:** Up to 8 periods can be configured for each day.
6. Click **Save** to save the current settings and **Cancel** to return to the previous interface.
7. On the Record Settings interface, you can view the configured recording schedule.
8. If you want to configure the other cameras with the same settings, choose the camera and click **Copy**. You can also select **All** to copy the current settings to all cameras.
9. Click **Apply** to save the current settings and **Cancel** to return to the previous interface.

### Configuring Motion Detection

Follow the steps to set the motion detection parameters for the Encoder device. In the live view mode, once a motion detection event takes place, the device can analyze it and do many actions to handle it. Enabling motion detection function can trigger certain channels to start recording, or trigger full screen monitoring, audio warning, notify the surveillance center and so on. In this chapter, you can follow the steps to schedule a record which triggered by the detected motion.

**Steps:**

1. On the Camera Settings interface, click **Set** beside Motion Detection to enter the **Motion Detection Settings** interface.



2. Select the camera for configuring motion detection.
3. Click the checkbox of **Enable** item to enable motion detection.
4. Set the sensitivity level. Up to 6 levels and OFF are selectable.

- Click the **Set** button beside Area Settings to set motion detection area.



- Click **Start Drawing**, and then use the mouse to click two points on the live view screen to draw area for motion detection.
- To clear the motion detection area (s), click **Clear All**.
- Click the **Set** button beside Arming Schedule to configure the arming schedule of motion detection for the current camera.



- Click the **Set** button beside Linkage Action to configure the linkage method. If the Trigger Alarm Output is selected, you should click the **Set** button to configure the triggered alarm output (s).

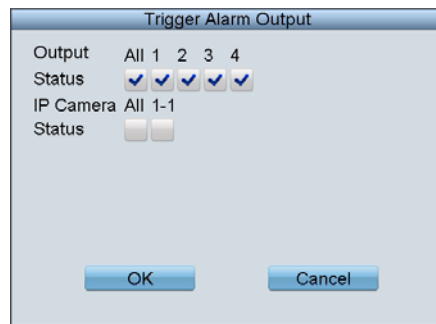

- After having configured the above setting and if you want to configure the other cameras with the same settings, choose the camera and click **Copy**. You can also select **All** to copy the current settings to all cameras.
- Click **Apply** to save the current settings and **Cancel** to return to the previous interface.

## Configuring Video Loss Detection

Detect the video loss of a camera and take alarm response action(s).

### Steps:

- On the Video Loss interface, click **Set** beside Video Loss to enter the **Video Loss Detection** interface.

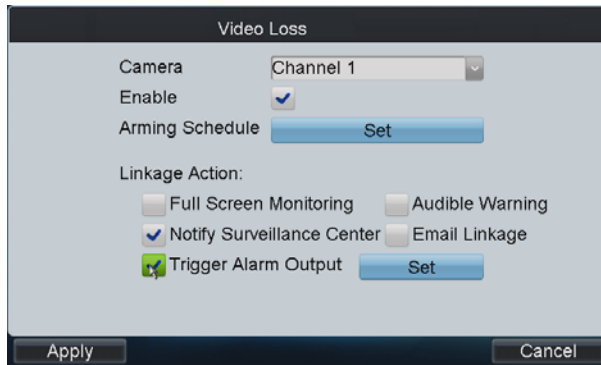

2. Select the camera for configuring video loss detection.
3. Click the checkbox of **Enable** item to enable video loss detection.
4. Click the **Set** button beside Arming Schedule to configure the arming schedule of video loss detection for the current camera.



5. Set the Linkage Action by selecting the methods list below. If the Trigger Alarm Output is selected, you should click the Set button to configure the triggered alarm output (s).

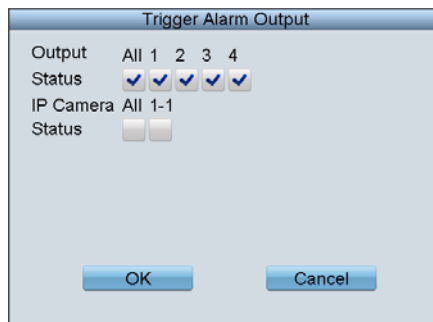

6. After having configured the above setting and if you want to configure the other cameras with the same settings, choose the camera and click **Copy**. You can also select **All** to copy the current settings to all cameras.
7. Click **Apply** to save the current settings and **Cancel** to return to the previous interface.

## Configuring Video Tampering Alarm

Trigger alarm when the lens is covered and take alarm response action(s).

### Steps:

1. On the Camera Settings interface, click **Set** beside Tampering Alarm to enter the **Tampering Alarm** settings interface.



2. Select the camera for configuring video tampering detection.
3. Click the checkbox of **Enable** item to enable video tampering detection.
4. Set the sensitivity level to High, Middle or Low.
5. Click the **Set** button beside Area Settings to set video tampering detection area. Please refer to the settings of motion detection area.
6. Click the **Set** button beside Arming Schedule to configure the arming schedule of video loss detection for the current camera.
8. Set the Linkage Action by selecting the methods list below. If the Trigger Alarm Output is selected, you should click the Set button to configure the triggered alarm output (s).
9. After having configured the above setting and if you want to configure the other cameras with the same settings, choose the camera and click **Copy**. You can also select **All** to copy the current settings to all cameras.
10. Click **Apply** to save the current settings and **Cancel** to return to the previous interface

## Configuring Privacy Mask

You are allowed to configure the four-sided privacy mask zones that cannot be viewed by the operator.

### Steps:

1. On the Camera Settings interface, click **Set** beside Privacy Mask to enter the **Privacy Mask** settings interface.

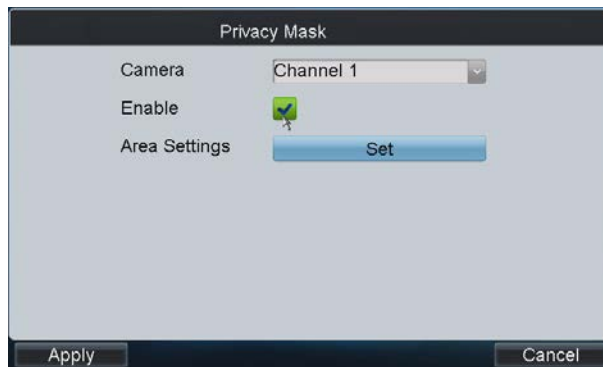

2. Select the camera for configuring privacy mask.
3. Click the checkbox of **Enable** item to enable privacy mask.
4. Click the **Set** button beside Area Settings to set privacy mask area. Please refer to the settings of motion detection area.
5. Click **Apply** to save the current settings and **Cancel** to return to the previous interface.



## Configuring IP Camera

If the current Encoder device is Hybrid DVR or NVR type, you can also enter the **Channel List** interface by clicking **Set** beside IP Camera Management on the Camera Settings interface.

### Adding IP Camera:

1. Click the IP Camera List tag to enter the IP camera management interface.
2. Click **Add** to enter the IP Camera Parameters interface.

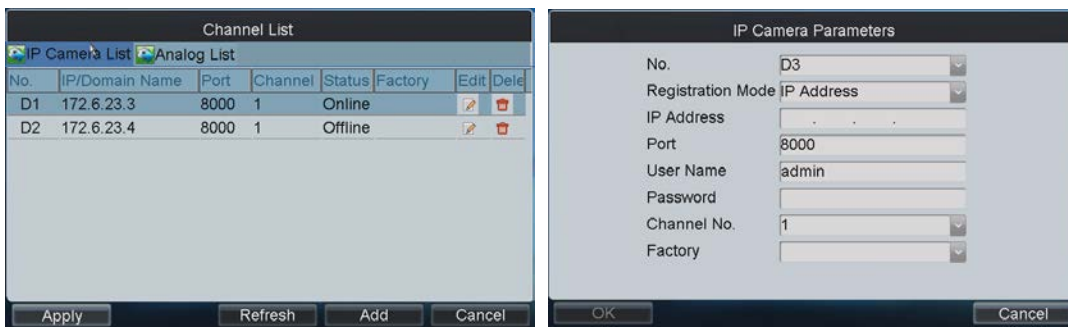

3. Configure the Camera No., Registration Mode (IP address/domain name), IP address/ Domain name, Port, User Name, Password, Channel No. and Factory (protocol type) to add the IP camera.
4. Click **OK** to save the settings.
5. On the Channel List interface, click **Apply** to finish the adding of the IP camera.

### Editing Status of Analog Camera:

For Hybrid DVR, you can view the status of the connected analog camera, as well as increase the number of IP camera to add by changing the disabling the analog camera (s).

1. Click the Analog List tag to enter the analog camera management interface. You can the information of the connected analog camera.
2. Click **Status** to enter the Analog Camera Status interface.

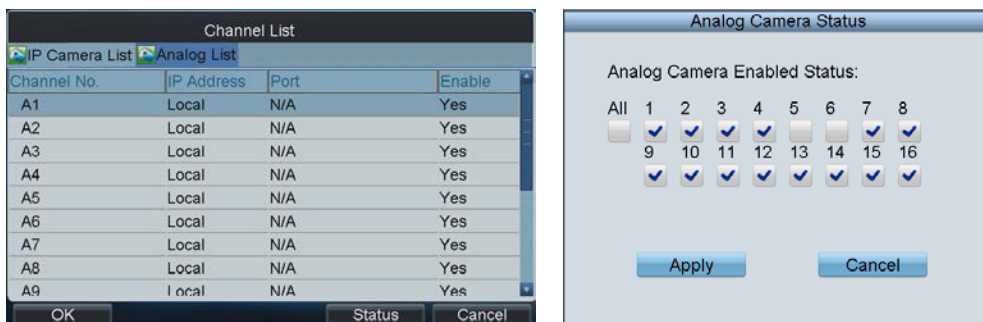

3. You can de-select the camera (s) to disable the analog camera(s) connected.

## 4.1.4 Alarm Settings

Click **Alarm** on the remote settings interface to enter the **Alarm Settings** interface where you can configure the alarm input, alarm output and manual alarm.

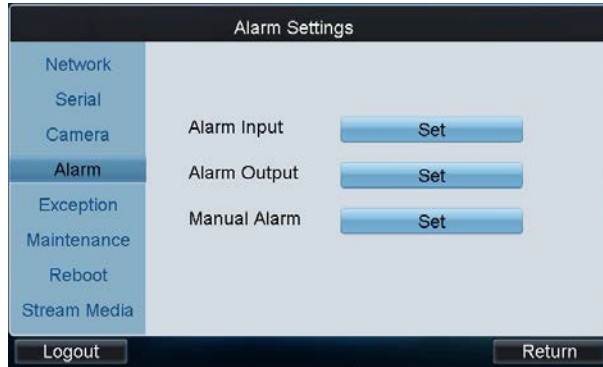

### 1. Configuring Alarm Input

- (1) Click **Set** beside Alarm Input to enter the Alarm Input Settings interface.
- (2) Select the alarm input for configuration.
- (3) Edit the Alarm Name.
- (4) Select the Alarm Type to Normally Open or Normally Close.



- (5) Set the handling action for the selected alarm input by clicking the checkbox of Handling Alarm. Configure the Arming Schedule and Linkage Action to set up its alarm response actions, as well as triggered camera and PTZ linkage (calling defined preset / patrol / pattern).

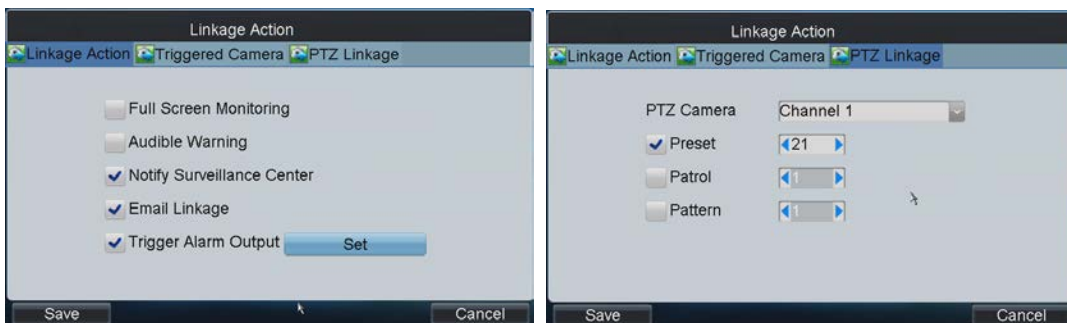

- (6) After having configured the above setting and if you want to configure the other cameras with the same settings, choose the camera and click **Copy**. You can also select **All** to copy the current settings to all cameras.
- (7) Click **Apply** to save the current settings and **Cancel** to return to the previous interface.

**Note:** Please refer to the User Manual of the current DVR for detailed instructions.

### 2. Configuring Alarm Output



- (1) Click Set beside Alarm Output to enter the **Alarm Output Settings** interface.
- (2) Select the alarm output for configuration.
- (3) Set the Hold For (duration) time for the alarm output.



- (4) Set the Dwell Time (duration) for the alarm output.
- (5) Configure the Arming Schedule of the alarm output.
- (6) After having configured the above setting and if you want to configure the other cameras with the same settings, choose the camera and click **Copy**. You can also select **All** to copy the current settings to all cameras.
- (7) Click **Apply** to save the current settings and **Cancel** to return to the previous interface.

### 3. Configuring Manual Alarm

- (1) Click Set beside Manual Alarm to enter the **Manual Alarm Settings** interface.
- (2) Select the alarm output (s) for manual triggering.

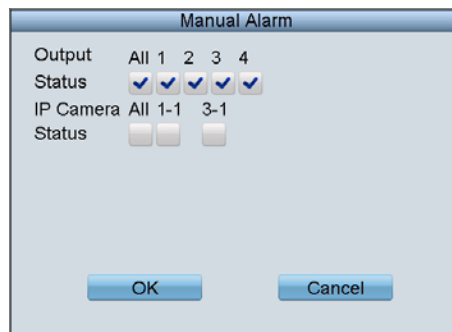

- (3) Click **OK** to return to the Alarm Settings interface.

## 4.1.5 Exceptions

Configure the exception handling method (s) for each exception type.

### Steps:

1. Click **Exceptions** on the remote settings interface to enter the **Exception Settings** interface.
2. Select the exception type to configure with handling method (s). The exception types include:
  - HDD Full:** The HDD is full.
  - HDD Error:** Writing HDD error, unformatted HDD, etc.
  - Network Disconnected:** Disconnected network cable.
  - IP Conflicted:** Duplicated IP address.
  - Illegal Login:** Incorrect user ID or password.

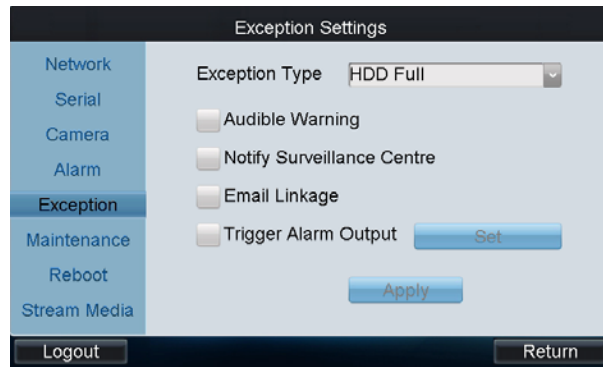

3. Select the handling method (s) by clicking the checkbox (s) for the selected exception type.
  - Audible Warning:** Audible *beep* when an alarm is detected.
  - Notify Surveillance Center:** Send an exception or alarm signal to remote alarm host when an event occurs. The alarm host refers to the PC installed with Remote Client.
  - Email Linkage:** Send an email with alarm information to a user or users when an alarm is detected.
  - Trigger Alarm Output:** Trigger an alarm output when an alarm is triggered. You can click the **Set** button to set the alarm output (s) to trigger.
4. Click **Apply** to save the current settings.

### 4.1.6 Maintenance

Click **Maintenance** on the remote settings interface to enter the **Device Management** interface.



- HDD Management:** Set and initialize HDD, and set HDD in group management.
- User Management:** Add/edit/delete user account, and assign operating permissions for each user.
- Device Information:** View the version and basic information of the encoder device.
- Device Upgrade:** Remotely upgrade the device by USB file.
- Import/Export:** Import/export configuration files.
- Restore Default:** Restore factory default settings.
- Remote Panel:** Use the remote front panel of the device to realize operation.

### 4.1.7 Stream Media Settings

**Purpose:**

The stream media sever only takes effect when the video needs to be decoded and displayed on the video wall. The decoder connects with the stream media server to get the video stream.

**Steps:**

1. Click **Stream Media** on the remote settings interface to enter the **Stream Media Settings** interface.

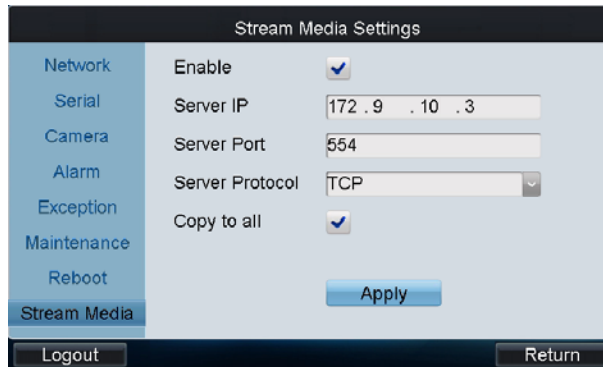

2. Enable the Stream Media by checking the checkbox.
3. Input the IP address and port of the server.  
**Note:** The Server IP refers to the IP address of the PC on which the stream media software is running.
4. You can check the checkbox of **Copy to all** to copy the current stream media settings to all encoding devices under the current login user. If you uncheck it, the stream media settings are applicable to the current encoding device only.
5. Click **Apply** to save the settings.

## 4.2 Decoder Settings

Click the  of a decoder on the **Device List** interface and enter its remote settings.

On this interface, you can configure the settings for network, RS-232/RS-485 serial port, output, decoding status, maintenance, etc.

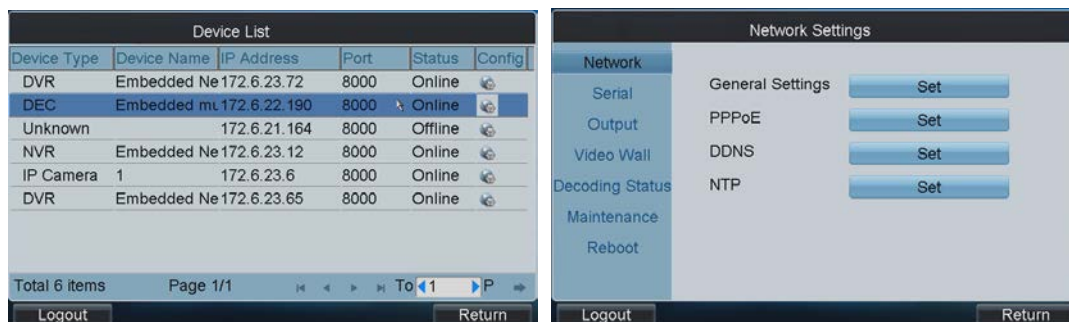

### 4.2.1 Network Settings

Click **Network** on the remote settings interface to enter the **Network Settings** interface. You can configure the general settings, advanced settings, PPPoE, DDNS and NTP parameters of the decoder.

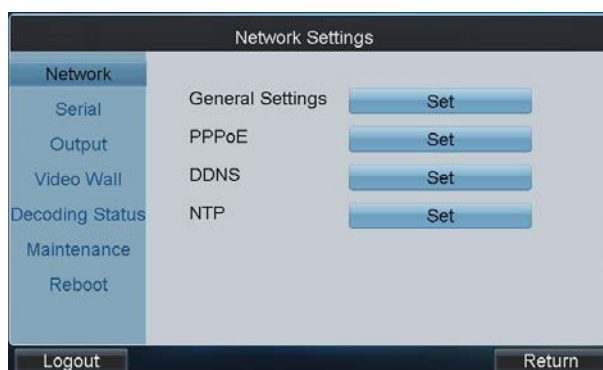

Please refer to the Network Settings of the Encoder for details.

## 4.2.2 Serial Port Settings

Click **Serial** on the remote settings interface to enter the **Serial Port Settings** interface.



You can set the RS232 port and RS485 parameters.

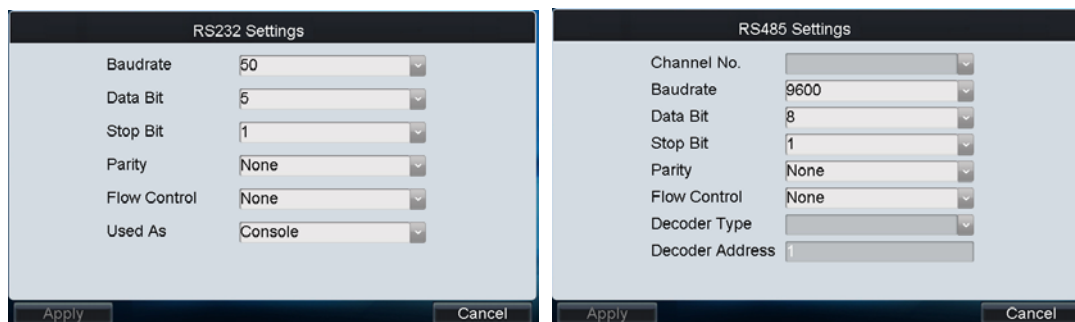

## 4.2.3 Output Settings

You can configure parameters for the display of decoded output video on monitor.

**Steps:**

1. Click **Output** on the remote settings interface to enter the **Output Settings** interface.

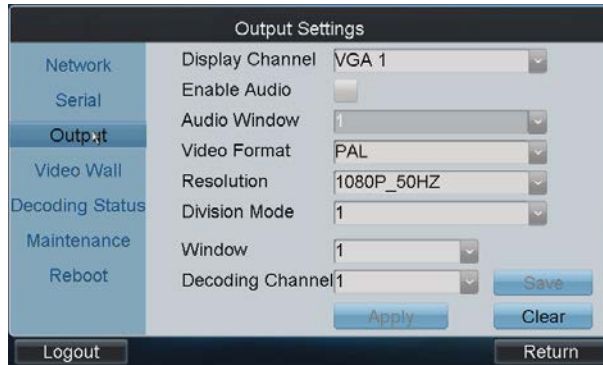

2. Select the display channel.
3. Enable audio and configure it for a window if required.
4. Set the video format and resolution of the decoded video output.
5. Select the window-division mode (1/2/4-division).
6. Configure window for relevant channel.
  - (1) Select a window and its relevant channel.
  - (2) Click **Save** to save the current window settings.
  - (3) Repeat the same steps to configure the other windows for their related channels.
7. After having configured the above settings, click **Apply** to finish the settings or **Clear** to cancel the settings.

#### 4.2.4 Video Wall

If the connected decoder is DS-6400HDI-T or DS-6400HDI-S, the video wall display is supported. You can decode the video signal and display it on the video wall.

##### Steps:

1. Click **Video Wall** on the remote settings interface to enter the **Video Wall** interface.



2. Select the video wall No. to configure and enable the video wall display by checking the **Enable** checkbox.
3. Select the window-division mode.
4. Set the decoding channel and the output resolution.
5. Select the screen No. of the selected video wall and the output channel of the decoder.
6. After having configured the above settings, click **Apply** to finish the settings.

#### 4.2.5 Decoding Status

Click **Decoding Status** on the remote settings interface to enter the **Decoding Status** interface.

You can view the working status of each decode channel, including the decode state, stream type, package mode, video/audio frame rate, etc.



## 4.2.6 Maintenance

Click **Maintenance** on the remote settings interface to enter the **Device Management** interface.



**User Management:** Add/edit/delete user account, and assign operating permissions for each user.

**Device Information:** View the version and basic information of the decoder device.

**Device Upgrade:** Remotely upgrade the device by USB file.

**Import/Export:** Import/export configuration files.

**Restore Default:** Restore factory default settings.

## 4.3 Input Settings

Click **Input** on the main interface to enter the **Input Settings-Input List** interface.

The list has displayed all device cameras which can be controlled by the current login user.

Search by IP or domain is supported. Input the IP address or domain of the device in the text field and click the **Search** button.

**Note:** The camera name shown in the Camera Name is obtained from the corresponding device.

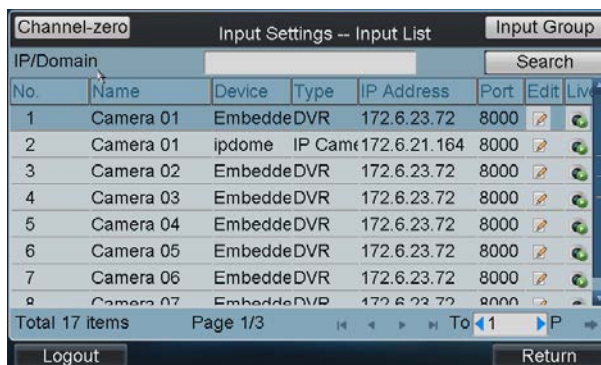

### 4.3.1 Starting Local Live View

**Steps:**

1. Select a camera from the input list and click the icon to start the local live view.



2. You can press the **NEXT** or **PREV** button to view the video of the next or previous camera.

### 4.3.2 Live View by Channel-zero

**Steps:**

1. Click the **Channel-zero** button on the **Input Settings-Input List** interface to enter the **Channel-zero** settings interface:

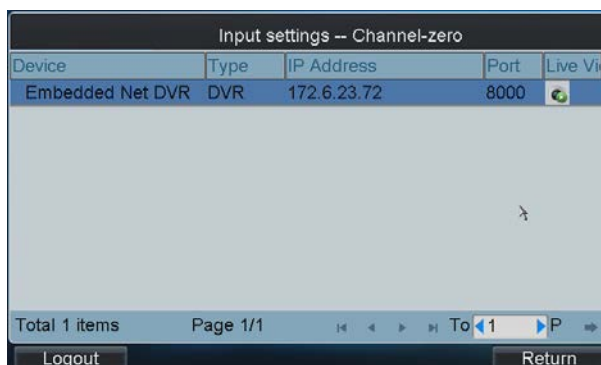

2. Select an encoding device from the list and click the icon to enter the local live view by the channel-zero.

**Note:** The channel-zero must be supported by the connected encoding device and has been enabled.

### 4.3.3 Editing a Camera

Select a camera from the Input **Settings-Input List** interface, and click  to edit the camera name, camera No., protocol and stream type.

**Note:** The Camera No. should be set uniquely from 1 to 999999.

### 4.3.4 Setting Input Group

**Steps:**

1. Click **Input Group** to enter the **Input Settings-Input Group** interface.
2. Click  to select the group No. from the drop-down menu, set the cycle time for the group and click the **Save** button.

**Note:** Up to 16 camera groups can be added.

3. Click the **Add Camera** key to enter the **Add Camera** interface:

No.	Name	Device	Type	IP Address	Port
1	Camera 0173	7308HF	DVR	172.10.26.25	8000
2	Camera 02	7308HF	DVR	172.10.26.25	8000
3	Camera 03	7308HF	DVR	172.10.26.25	8000
4	Camera 04	7308HF	DVR	172.10.26.25	8000
5	Camera 05	7308HF	DVR	172.10.26.25	8000
6	Camera 06	7308HF	DVR	172.10.26.25	8000
7	Camera 07	7308HF	DVR	172.10.26.25	8000
8	Camera 08	7308HF	DVR	172.10.26.25	8000

4. Select the cameras from the list to be added to the group, and then click **Add** to finish the setting.
5. Click **Finish** to return to the **Input Group** interface, where you can view the successfully added cameras for



the current group.

You can click  to delete the added camera.









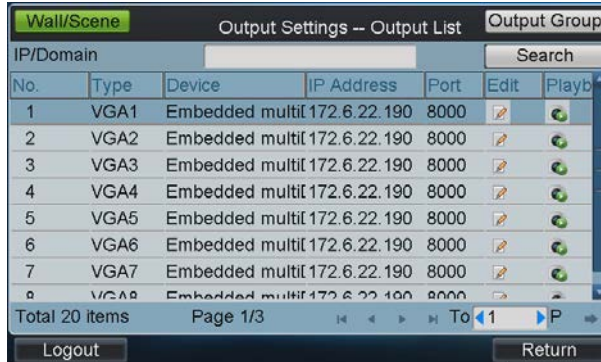







## 4.4 Output Settings

Click **Output** on the main interface to enter the **Output Settings** interface.

Search by IP or domain is supported. Input the IP address or domain of the device in the text field and click the **Search** button.

The list has displayed all output channels added to the current login user.



No.	Type	Device	IP Address	Port	Edit	Playb
1	VGA1	Embedded multi	172.6.22.190	8000		
2	VGA2	Embedded multi	172.6.22.190	8000		
3	VGA3	Embedded multi	172.6.22.190	8000		
4	VGA4	Embedded multi	172.6.22.190	8000		
5	VGA5	Embedded multi	172.6.22.190	8000		
6	VGA6	Embedded multi	172.6.22.190	8000		
7	VGA7	Embedded multi	172.6.22.190	8000		
8	VGA8	Embedded multi	172.6.22.190	8000		

Total 20 items Page 1/3 To 1 P

### 4.4.1 Playback on Monitor

Select an output channel from the output list and click the  icon to enter the Playback interface.

**Note:** Before operating the playback, you must configure the output settings first. Please refer to 4.2.3 *Output Settings*.

#### Playback by File

**Steps:**

1. Click the **By File** tab to enter the playback by file interface.



MON:1 Playback

By File  By Time

Display Window: 1

Camera No.:

Record Type: All

By Card No.:

Start Time: 2013-10-22

End Time: 2013-10-22

Logout Search Return

2. Input the display window.

**Note:** Please refer to the window-division mode in the 4.2.3 *Output Settings* before inputting the display window here.

3. Input the Camera No. for playback.

If the encoding device is ATM DVR, you can input the Card No.

4. Select the record type and file type.
5. Set the start time and end time of the video files for playback.
6. Click **Search** to search the matched video files.
7. The searching results can be viewed on the Playback File List interface.

File Name	Start Time	End Time	Size	Type
ch01_08(2013-01-25 11:28:59	2013-01-25 11:28:59	2013-01-25 12:33:56	725.1MB	Unlock
ch01_08(2013-01-25 12:33:56	2013-01-25 12:33:56	2013-01-25 14:05:44	1016.4MB	Unlock
ch01_08(2013-01-25 14:05:44	2013-01-25 14:05:44	2013-01-25 14:52:19	521.9MB	Unlock
ch01_08(2013-01-25 14:54:11	2013-01-25 14:54:11	2013-01-25 14:57:35	26.9MB	Locked
ch01_08(2013-01-25 15:01:14	2013-01-25 15:01:14	2013-01-25 15:43:12	467.1MB	Unlock
ch01_08(2013-01-25 15:43:12	2013-01-25 15:43:12	2013-01-25 17:13:33	1016.4MB	Unlock
ch01_08(2013-01-25 17:13:33	2013-01-25 17:13:33	2013-01-25 18:42:56	1016.2MB	Unlock
ch01_08(2013-01-25 18:42:56	2013-01-25 18:42:56	2013-01-25 19:22:55	457.7MB	Unlock

8. Select the file for playback from the list and click **Playback** to play back the video file.  
**Note:** The Playback Control buttons on the left side of the control panel are supported during the playback.

## Playback by Time

### Steps:

1. Click the **By Time** tab to enter the playback by time settings interface.

2. Input the display window.  
**Note:** Please refer to the window-division mode in the 4.2.3 Output Settings before inputting the display window here.
3. Input the Camera No. for playback.
4. Set the start time and end time of the video files for playback.
5. Click **Playback** to start playback.

**Note:** The Playback Control buttons on the left side of the control panel are supported during the playback.

## 4.4.2 Editing an Output Channel

Select an output channel from the on the **Output Settings-Output List** interface, and click  to edit the output No..

**Note:** The Output No. should be set uniquely from 1 to 999999.



### 4.4.3 Setting Output Group

**Steps:**

1. Click **Output Group** to enter the **Output Settings-Output Group** interface.
2. Click  to select the group No. from the drop-down menu.

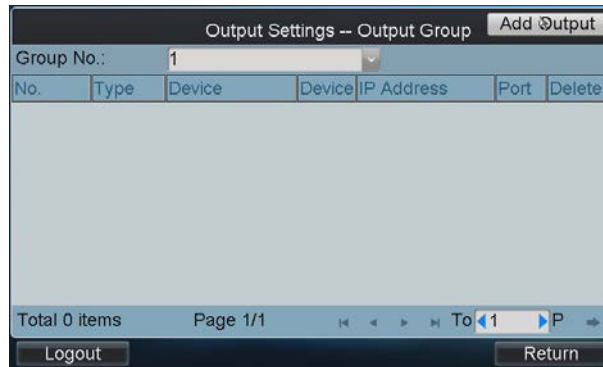

3. Click the **Add Output** key to enter the **Add Output** interface:

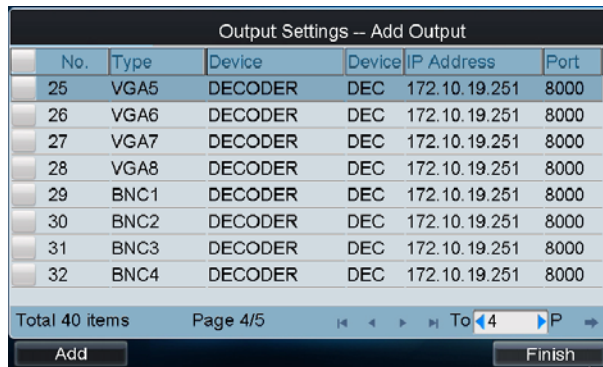

4. Select the outputs from the list to be added to the group, and then click **Add** to finish the setting.
5. Click **Finish** to return to the **Output Group** interface, where you can view the successfully added output channels for the current group.

You can click  to delete the added output.

### 4.4.4 Setting Video Wall / Scene

**Steps:**

1. Click the **Wall/Scene** button to enter the Video Wall/Scene List.

No.	Name	Device	IP Address	Port	Edit
1	Screen 1	Embedded m	172.6.22.190	8000	
2	Screen 2	Embedded m	172.6.22.190	8000	
3	Screen 3	Embedded m	172.6.22.190	8000	
4	Screen 4	Embedded m	172.6.22.190	8000	

Total 4 items Page 1/1 To 1 P

Logout Return

2. Click to enter the editing interface.
3. Edit the No. for the video wall / scene on your demand.

Video Wall/Scene -- Edit

No.

Name Video Wall1

Device Embedded multiDecoder

IP Address 172.6.22.190

Port 8000

OK Cancel

4. Click **OK** button to save the setting.

## 4.5 Macro Settings

The macro command can be used for operating a series of continuous actions in sequence.

**Operation:** Press the “Num + MAC” keys to call the programmed macro command.

Click **Macro** on the main interface to enter the Macro Settings interface.

No.	Macro Name	View	Run	Delete
-----	------------	------	-----	--------

Total 0 items Page 1/1 To 1 P

Logout Return

Add Macro

### Adding Macro

Click **Add Macro** to enter the **Macro Setting-Add Macro** interface. Edit the macro name, and press the command keys on the keyboard to enter the text box below. Finally, click **Add** to add the current macro command.

#### Notes:

- Up to 128 macro commands can be added.
- Max. 6 numerals can be included in a macro command.
- The local decoding and live view operation is not supported currently.

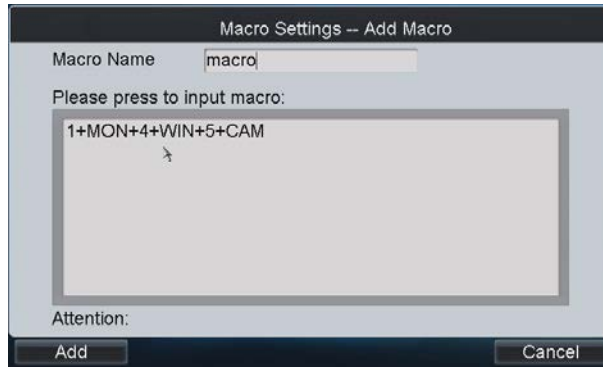

### Viewing Macro

The added Macro commands are listed on the **Macro Settings-Macro List** interface.

You can click  to view each macro command.

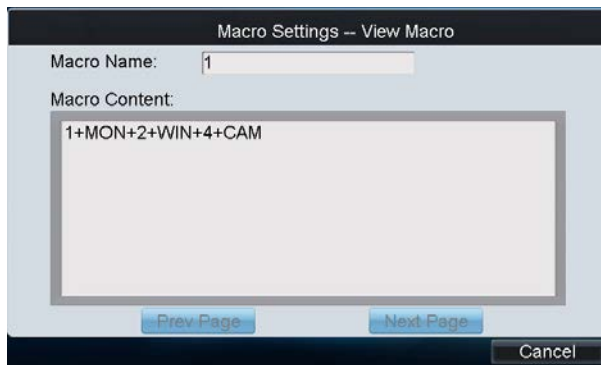

### Running Macro

Select a command from the list and click  to run the command, or directly click **Num + MAC** keys on the interface to call the macro command.

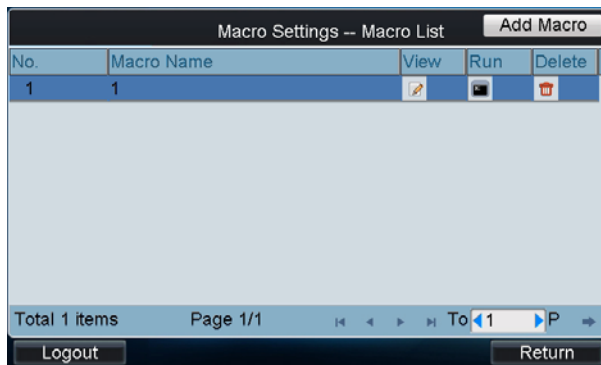

### Deleting Macro

You can click  to delete the added macro command.

## 4.6 Playback

The video files stored in the encoding device can be played back through the related decoder. Three playback modes are available: playback by USB file, playback by time and playback by file.

Click **Playback** on the main interface to enter the Local Playback interface.

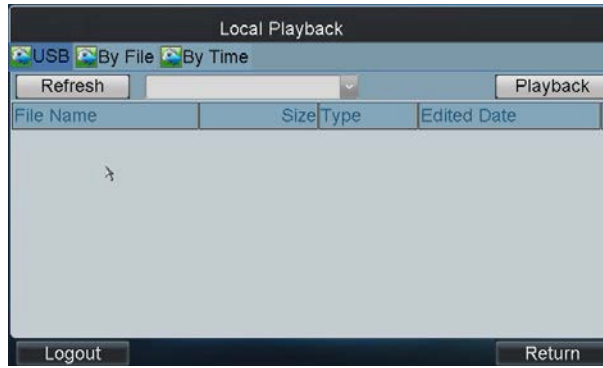

### 4.6.1 Playback by USB File

**Steps:**

1. Connect your USB disk to the keyboard.
2. Click the **USB File** tab on the **Local Playback** interface to enter the Playback by Local File interface.

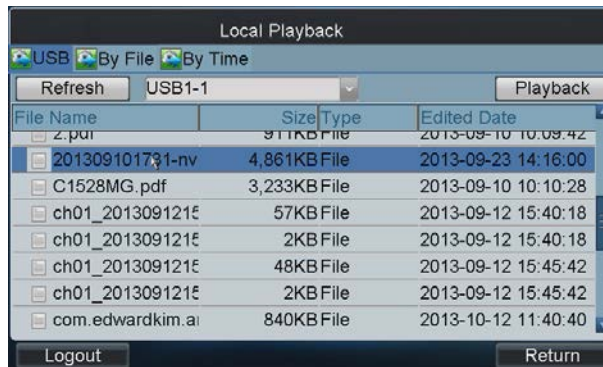

3. Select the video file from the USB disk for playback.
4. Click **Playback** to play the selected video file.



### 4.6.2 Playback by File

**Steps:**

1. Click the **By File** tab on the Local **Playback** interface to enter the Playback by File interface.



2. Input the Camera No. for playback.
3. Select the record type and file type.  
If the encoding device is ATM DVR, you can input the Card No.
4. Set the start time and end time of the video files for playback.
5. Click **Search** to search the matched video files.

(1) The searching results can be viewed on the Playback File List interface.

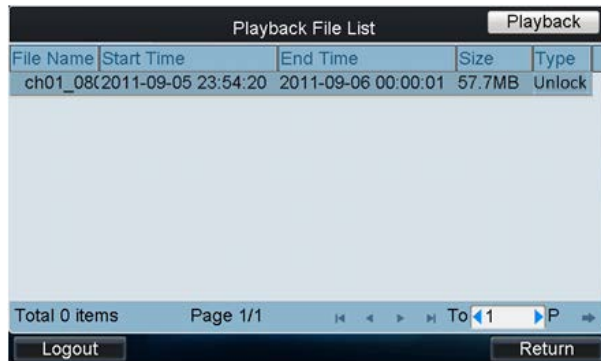

(2) Select the file for playback from the list and click **Playback** to play back the video file.

### 4.6.3 Playback by Time

1. Click the **By Time** tab on the **Local Playback** interface to enter the Playback by Time interface.

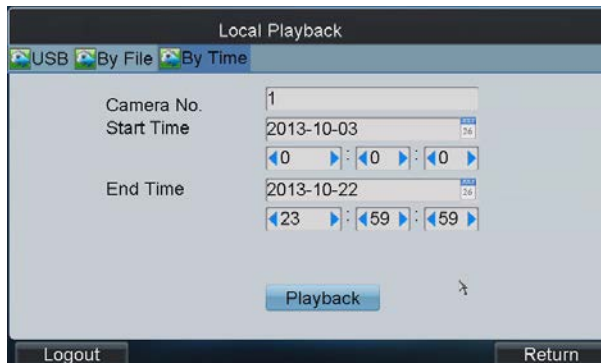

2. Input the Camera No. for playback.
3. Set the start time and end time of the video files for playback.
4. Click **Playback** to play back the recoding file.

## 4.7 Advanced Settings

Click **Advanced** on the main interface to enter the **Advanced Settings** interface where you can configure the password, AUX key, live view performance and PTZ speed control settings.



### 4.7.1 Password Settings

Click **Password** on the Advanced Settings interface to enter the Password Settings interface.

It is allowed to edit the password for the current login user.

Enter the current password and new password, and then click **Apply** to finish the password modification.

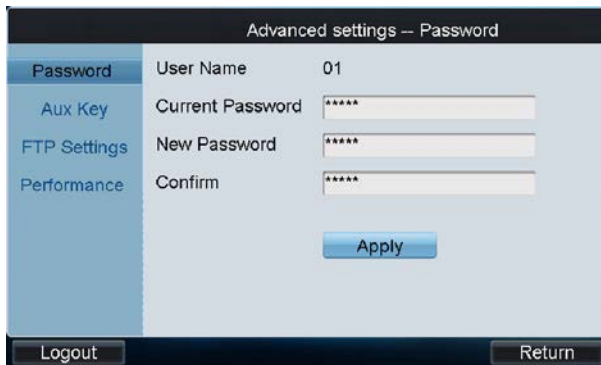

### 4.7.2 AUX Key Settings

Click **Aux Key** on the Advanced Settings interface to enter the Aux Key Settings interface.

On the **Advanced Settings-Aux Key** interface, the **Aux Key 1** and **Aux Key 2** correspond to the AUX1 and AUX2 keys on the keyboard respectively.

The function of AUX1/AUX2 can be set to **Two-way Audio**, **Picture Capture** or **Video Wall/Scene Switch** control.

Click  to select the Aux function for each Aux Key, and then click **Apply** to save the settings.





### 4.7.3 Live View & PTZ Speed Settings

Click **Performance** on the Advanced Settings interface to enter the network performance and PTZ speed settings interface.

It allows you set the network performance of local live view on keyboard. Five levels are selectable.

You can also set the PTZ movement speed of the connected PTZ camera by using the joystick. Four levels are selectable.

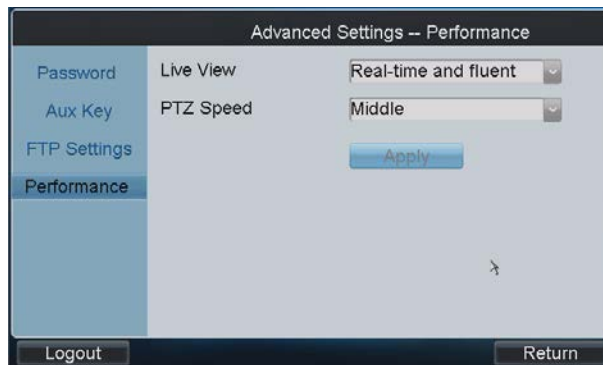

### 4.7.4 FTP Settings

The video files or captured pictures can be uploaded to FTP server.

**Steps:**

1. Click **FTP Settings** on the Advanced Settings interface to enter the FTP Settings interface.

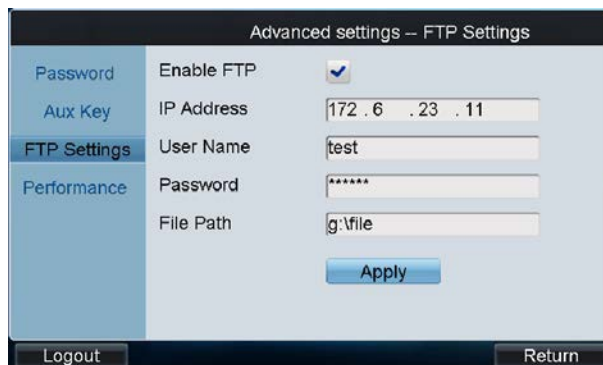

2. Check the checkbox of **Enable FTP**.

**Note:** If the **Enable FTP** is unchecked, the video files or captured pictures will be saved in the U-flash disk.

3. Enter the IP address of the FTP server.
4. Enter the user name and password for login to the FTP server.
5. Enter the file path to which the video files and captured pictures are uploaded.
6. Click **Apply** to save the settings.

## 4.8 Logout

Click **Logout** on the main interface, and the message box “Logout now?” will pop up. Click **Yes** to confirm the logout, or **No** to cancel the operation.

After logout of current login user, the system will return to the User Login interface.



The screenshot shows a 'User Login' dialog box. It has a title bar with the text 'User Login'. Below the title bar, there are three input fields: 'User Name' with the value '01', 'Password' with masked characters '\*\*\*\*\*', and 'Remember Password' which is checked. At the bottom, there are two buttons: 'Login' and 'Exit'.

## 4.9 Reboot

Click **Reboot** on the main interface, the message box “Reboot now?” will pop up.

Click **Yes** to confirm the reboot, or **No** to cancel the operation.

## 4.10 Shutdown

Click **Shutdown** on the main interface, the message box “Shut down now?” will pop up.

Click **Yes** to confirm the shutdown, or **No** to cancel the operation.

## Chapter 5 Keyboard Operation

### 5.1 Shortcut Operation

The operating user must log in the keyboard to realize all shortcut operations (except LOCK).

**Shortcut Operation:** Press the **Num** keys on the keyboard to enter the shortcuts operation interface.

**Notes:**

- When user enters the shortcuts operation interface by inputting the *Num* key, press *ESC* to cancel the inputted numeral from the screen and start the shortcut operation.
- When user enters the shortcuts operation interface by inputting the *SET* key, user should press it again before starting the shortcut operation.

In the shortcuts operation interface, the left part has displayed the current output channel, and user can select different window-division display modes, set input channel for each window, or configure other shortcut operations.

And the right part of the interface is used for displaying the current key input and some shortcut operations.



### 5.2 Local Live View

The local live view refers to display the video signal from the input channel through the network keyboard. Currently, only the 1-window display mode for 1 decoding channel is supported. In the preview mode, user can operate other shortcut functions.

**Steps:**

1. Press the *0+MON* keys to enter local preview.
2. Press the *Num + CAM* keys to select the camera input for display on the screen.

**Note:** In the local operation status, it is unallowable to operate the window (WIN), camera group (CAM-G), multi-division display (MULT) and camera tour (TOUR) functions.



3. Press the **ESC** key on the keyboard to enter full-screen preview mode.



**Notes:**

- Up to 1080P resolution is supported for local live view.
- User can press the **O+CAM** keys to stop the live view of the current window.

## 5.3 Display of Decoded Video on Monitor

### 5.3.1 Setting Multi-division Display

You can select different multi-division display modes for the selected output channel. Currently, 1/4/9/16-division display modes are configurable.

**Steps:**

1. Press the **Num + MON** keys to select the monitor.
2. Press the **Num + MULT** keys to select the multi-division display mode for the output channel.

**Note:** In the local live view mode when you input **O+MON** keys, the multi-division display mode is not supported.



**Note:** Corresponding error message will appear on the screen when user performs wrong operation. E.g., when the multi-division number entered is not supported by the current output channel, the message “Window mode error.” will appear.

### 5.3.2 Setting Camera to Monitor

The selected input signal can be outputted and displayed by the decoding channel on the monitor. Currently, the supported decoding resolution includes: QCIF, CIF, 2CIF, DCIF, 4CIF, 720p, 1080p, VGA, UXGA, etc. The output interface can be selected to BNC/VGA/HDMI/DVI.

**Steps:**

1. Press the *Num + MON* keys to select the monitor.
2. Press the *Num + WIN* keys to select the display window on the monitor.  
You can also directly touch the screen to select the display window.
3. Press the *Num + CAM* keys to select the input camera.

**Example:**

You can input the “1+MON, 2+WIN, 3+CAM” keys to decode the video signal from camera 3 and display it on window 2 of monitor 1.

When you press the 0+CAM keys, it will stop the dynamic decoding of the current window. If no display window is selected, the decoding of the 1<sup>st</sup> window will be stopped by default.

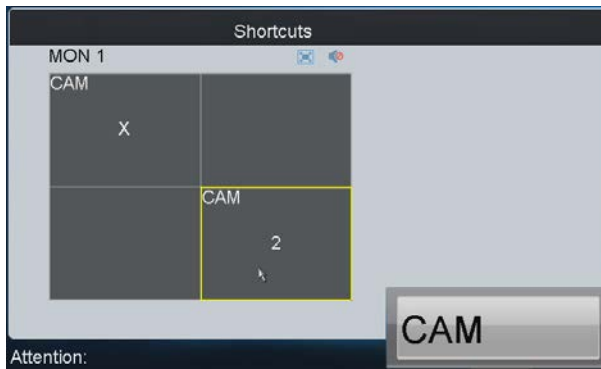

**Description of icons:**

Switch to full screen of sub screen	Restore	Audio off	Audio on

**Notes:**

- In the local live view mode, when you input 0+MON keys, only the single-window display mode is supported.
- Corresponding error message will appear on the screen when you perform wrong operation.

### 5.3.3 Setting Camera Group to Monitor

The video signal from the selected camera group can be outputted to and displayed by the decoding channel on monitor.

1. When the number of cameras is equal to or less than the number of display windows on screen, e.g., 8 cameras→9 windows, then each camera will be displayed on its corresponding monitor respectively, e.g., camera 1 on window 1, camera 8 on window 8, etc.
2. When the number of cameras is more than the number of display windows on screen, e.g., 34 cameras→ 16

windows, then the camera 1-16 will be displayed on window 1-16, camera 17-32 on window 1-16, and camera 33-34 on window 1-2 in cycle view mode.

**Note:** The dwell time for the cycle view is set in the input group setting interface, refer to 4.3.4 Setting Input Group.

**Steps:**

1. Press the *Num + MON* keys to select the monitor.
2. Press the *Num + CAM-G* keys to select the input camera group to be decoded and displayed on the monitor.



**Notes:**

- In the local live view mode when you input *0+MON* keys, the multi-division display mode is not supported. When you press the *0+CAM* keys, it will stop the dynamic decoding of the current window.
- Corresponding error message will appear on the screen when you perform wrong operation.

### 5.3.4 Setting Camera Group to Window

The video signal from the camera group can be outputted to and displayed on the selected window of monitor in cycle.

**Note:** The dwell time for the cycle view is set in the input group setting interface, refer to 4.3.4 Setting Input Group.

**Steps:**

1. Press the *Num + MON* keys to select the monitor.
2. Press the *Num + WIN* keys or directly touch on the screen to select the display window.
3. Press the *Num + CAM-G* keys to select the camera group.

Example: You can input the “*1+MON, 2+WIN, 3+CAM-G*” keys to decode the video signal from camera group 3 and display it on window 2 of the monitor 1.

**Note:** In the local live view mode when you input *0+MON* keys, the cycle view function is not supported. When you press the *0+CAM* keys, it will stop the dynamic decoding of the current window.



**Note:** Corresponding error message will appear on the lower-left corner of the screen when you perform wrong operation.

### 5.3.5 Setting Camera Group to Monitor Group

The selected camera group signal can be outputted and displayed by the decoding channel on the selected monitor group.

1. When the number of cameras in the camera group is equal to or less than the number of monitors in the monitor group, e.g., 8 cameras→9 monitors, then each camera will be displayed on its corresponding monitor respectively, e.g., camera 1 on monitor 1, and camera 8 on monitor 8, etc.
2. When the number of cameras in the camera group is more than the number of monitors in the monitor group, e.g., 34 cameras→16 monitors, then the camera 1-16 will be displayed on monitor 1-16, camera 17-32 on monitor 1-16, and camera 33-34 on monitor 1-2 in cycle view mode.

**Note:** The default dwell time of cycle view is 30 sec.

**Steps:**

1. Press the *Num + MON-G* keys to select the monitor group.
2. Press the *Num + CAM-G* keys to select the camera group to be viewed in cycle on the specified monitor group.

**Note:** In this operation mode, each output channel in the selected monitor group will be displayed on the screen in 1-division mode by default.



### 5.3.6 Setting a Tour

Up to 64 cameras can be set in a tour, with the dwell time configurable. The default dwell time is 30 seconds.

When the system is not in the playback mode, you can directly press the SET key then the Num + TOUR keys to enter the tour settings interface.

**Steps:**

1. Press the *SET* key to enter the tour settings interface.
2. Press the *Num + TOUR* keys to set the selected tour.
3. Press the *Num + ENTER* keys to set the dwell time of the camera and the camera number.
4. Repeat Step 3 to set other cameras.
5. Press the *SET* key to finish the tour settings.

**Note:** The tour settings will not be saved after the keyboard is rebooted.

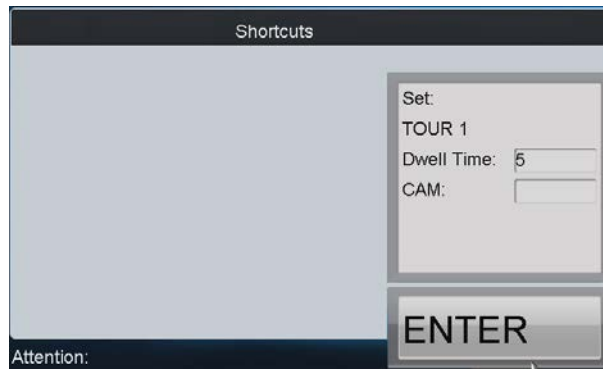

Up to 8 tours can be supported currently.

The dwell time of the tour is the length of time used for switching from one camera to the next camera in the tour.

All cameras are set with the same dwell time.

**Notes:**

- When the device is restarted, all the tour settings will be invalid.
- All programmed parameters will be cleared if you press the Num + TOUR keys again in the process of setting tour.
- Corresponding error message will appear on the screen when you perform wrong operation.

### 5.3.7 Calling a Tour

**Steps:**

1. Press the Num + MON keys to select the monitor for display.
2. Press the Num + TOUR keys to call the programmed tour to be displayed on the selected monitor.

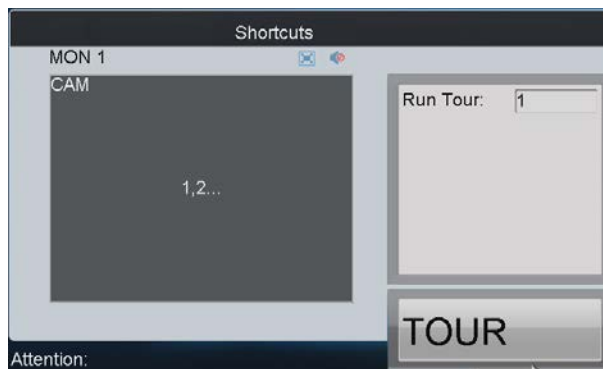

### 5.3.8 Setting a Group Tour

Multiple camera groups can be displayed on the specified monitors in tour respectively. Each user account is allowed to set up to 8 group tours, and each group can include 8 camera groups to specified monitors.

When the system is not in the playback mode, user can directly press the SET key and then Num + GROUP keys to enter the group tour settings interface.

**Steps:**

1. Press the SET key to enter the settings interface.
2. Press the Num + GROUP keys to set the group tour.
3. Press the Num + ENTER keys to set the monitor (MON) number.



4. Press the *Num + ENTER* keys to set the camera group (CAM-G) number.
5. Repeat step 3-4 to set other monitors and camera groups.
6. Press the SET key to finish the group tour settings.



**Notes:**

- The group tour settings will not be saved after keyboard reboot. And if you press the *Num + GROUP* keys in the process of setting the group tours, all previous settings will be cleared.
- Corresponding error message will appear on the screen when you perform wrong operation.

### 5.3.9 Calling a Group Tour

Multiple camera groups can be automatically displayed on related monitors respectively in tour by calling the programmed group tour, e.g., camera group 1 on monitor 1, camera group 2 on monitor 2, etc.

If multiple camera groups are configured for the same monitor, then it is available for the display of the last programmed camera group only.

The dwell time of group tour can be configured.

**Steps:**

Press the *Num + GROUP* keys to directly call the programmed group tour.



### 5.3.10 Operating Instant Playback

The recording files of the previous 5 seconds can be played back via the keyboard instantly.

**Steps:**

1. Press the *Num + MON* keys to select the monitor.
2. Press the *Num + WIN* keys to select the display window.
3. Press the *Num + CAM* keys to select the camera.

4. Press the  key to enter the instant playback interface.

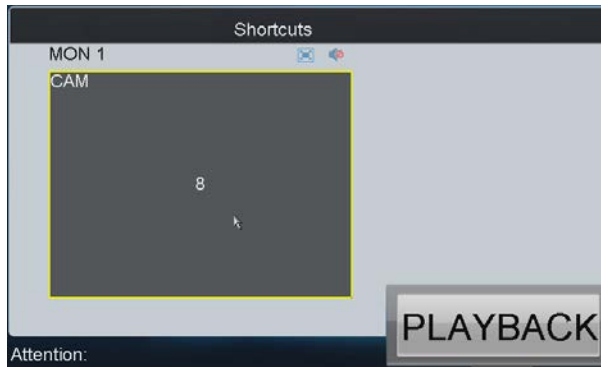

**Notes:**

- The local playback by time is not supported.
- You can press the  button to stop the instant playback.

**Other playback operation:** Rotate the outer ring of the shutter in clockwise direction to speed up the playback, with the max. speed capable of reaching 16X. And by rotating the outer ring of the shutter in anti-clockwise direction you can speed down the playback, with the min. speed capable of reaching 1/16X.

### 5.3.11 Operating Image Switch

**Steps:**

1. Set the usage of the Aux Key as the Video Wall/Scene Switch.  
Please refer to the 4.7.2 *AUX Key Settings* for detailed instructions.
2. Check the No. of Wall/Scene you want to set.  
Please refer to the 4.4.4 *Setting Video Wall / Scene* for detailed instructions.
3. Press *Num + AUX* keys to select the video wall/scene.
4. Press *Num + WIN* keys to select the screen (not for video wall).
5. Press *Num + CAM/CAM-G* to switch the selected camera or camera group on the screen.

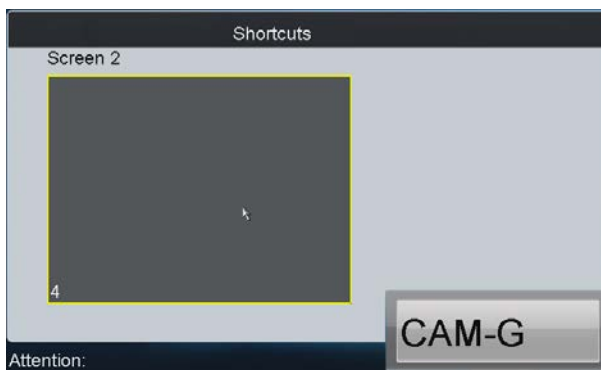

6. Press *0 + CAM* keys to stop decoding.

## 5.4 PTZ Control

### 5.4.1 PTZ Control Function

If the camera connected to the keyboard supports PTZ function, you are allowed to operate the LIGHT/FOCUS/IRIS/ZOOM/WIPER buttons to realize PTZ control.

Two operation methods can be used to realize PTZ control:

**Method 1:**

1. Press the *Num + MON* keys to select the monitor.
2. Press the *Num + WIN* keys to select the display window.

**Note:** When the current window is in cycle view mode, the keyboard will be unable to automatically connect with the camera and now it is invalid to operate the joystick.

**Method 2:**

1. Press the *Num + CAM* keys to directly select the camera.
2. When the camera connected to the keyboard supports PTZ function, operate the joystick and LIGHT/WIPER/FOCUS $\pm$ /IRIS $\pm$ /ZOOM buttons to realize PTZ control.

### 5.4.2 Setting a Preset

Select the output monitor or window and the keyboard is capable of automatically connecting with its corresponding camera. Operate the joystick to move PTZ to the desired position and then press the PRESET key to complete the preset settings. You are also allowed to directly select the camera by inputting *Num + CAM* keys and then press the PRESET key to start patrol settings.

- **Setting a Preset by Output Channel**

**Steps:**

1. Press the *Num + MON* keys to select the output channel.
2. Press the *Num + WIN* keys to select the display window.
3. Operate the joystick to move PTZ to the desired position.
4. Press the *Num + PRESET* keys to set the current position as the preset with entered number.

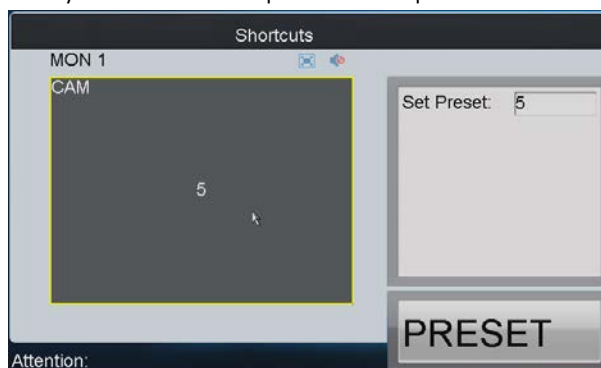

**Note:** Corresponding error message will appear on the screen when you perform wrong operation.

- **Setting a Preset by Input Channel**

**Steps:**

1. Press the *Num + CAM* keys to select the input channel.
2. Operate the joystick to move PTZ to the desired position.  
Press the *Num + PRESET* keys to set the current position as the preset with entered number.



**Notes:**

- It is invalid to input the 0+CAM keys in the current operation mode.
- Corresponding error message will appear on the screen when you perform wrong operation.

### 5.4.3 Calling a Preset

The programmed preset can be called to achieve the desired position. Select the output monitor or window and then press the *CALL* key on the keyboard to call the preset. You are also allowed to directly select the camera by pressing *Num + CAM* keys and then press the *CALL* key to realize preset callup.

- **Calling a Preset by Output Channel**

**Steps:**

1. Press the *Num + MON* keys to select the output channel.
2. Press the *Num + WIN* keys to select the display window.
3. Press the *Num + CALL* keys to call the programmed preset.

**Note:** This operation is valid only when the preset function is supported by the connected camera/dome.

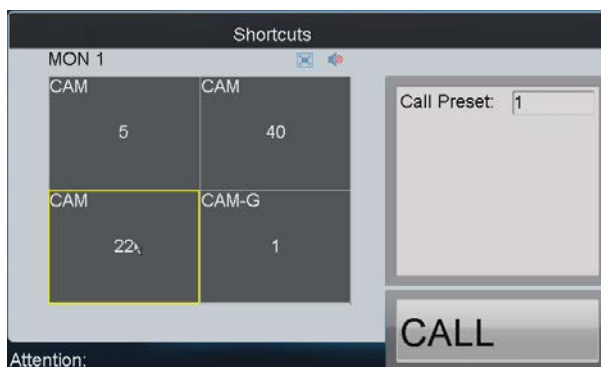

**Note:** Corresponding error message will appear on the screen when you perform wrong operation.

- **Calling a Preset by Input Channel**

**Steps:**

1. Press the *Num + CAM* keys to select the input channel.
2. Press the *Num + CALL* keys to call the programmed preset.

**Note:** It is invalid to input the 0+CAM keys in the current operation mode.



**Note:** Corresponding error message will appear on the screen when you perform wrong operation.

### 5.4.4 Setting a Patrol

Select the output monitor or window and the keyboard is capable of automatically connecting with its corresponding camera. Press the SET key on the keyboard and then press PATROL key to enter the patrol settings interface. You are also allowed to directly select the camera by inputting Num + CAM keys and then press the SET key to start patrol settings.

- **Setting a Patrol by Output Channel**

**Steps:**

1. Press the *Num + MON* keys to select the output channel.
2. Press the *Num + WIN* keys to select the display window.
3. Press the *SET* key to enter the settings interface.
4. Press the *Num + PATROL* keys to enter the patrol settings interface.
5. Input *Num* and press the *ENTER* key to set the preset number, stop time and speed respectively.
6. Repeat Step5 to set other presets.
7. Press the *SET* key again to finish the patrol settings.

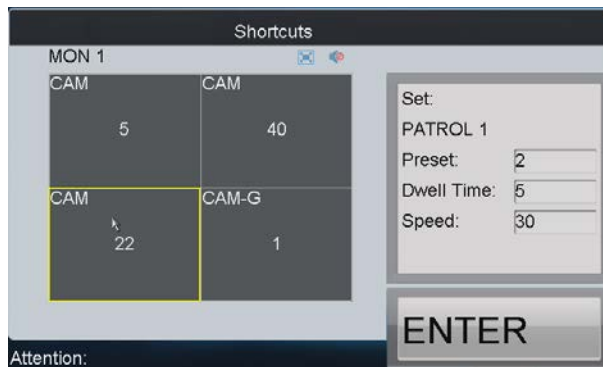

**Notes:**

- Corresponding error message will appear on the screen when you perform wrong operation.
- All programmed parameters will be cleared if you press the *Num + PATROL* keys again in the process of setting the patrol.

- **Setting a Patrol by Input Channel**

**Steps:**

1. Press the *Num + CAM* keys to select the input channel.
2. Press the *SET* key to enter the settings interface.
3. Press the *Num + PATROL* keys to enter the patrol settings interface.

4. Input *Num* and press the *ENTER* key to set the preset number, stop time and speed respectively.
5. Press the *SET* key again to finish the patrol settings.



**Notes:**

- It is invalid to input the *0+CAM* keys in the current operation mode.
- Corresponding error message will appear on the screen when you perform wrong operation.

### 5.4.5 Calling a Patrol

Select the output monitor or window and the keyboard is capable of automatically connecting with its corresponding camera. Press the *PATROL* key on the keyboard to call the programmed patrol. You are also allowed to directly select the camera and then press the *PATROL* key to realize patrol callup.

- **Calling a Patrol by Output Channel**

**Steps:**

1. Press the *Num + MON* keys to select the output channel.
2. Press the *Num + WIN* keys to select the display window.
3. Press the *Num + PATROL* keys to call the programmed pattern.

**Note:** This operation is valid only when the patrol function is supported by the connected camera/dome.

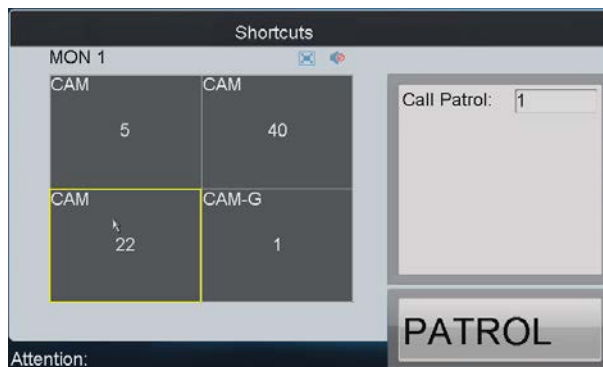

**Note:** Corresponding error message will appear on the screen when you perform wrong operation.

- **Calling a Patrol by Input Channel**

**Steps:**

1. Press the *Num + CAM* keys to select the input channel.
2. Press the *Num + PATROL* keys to call the programmed patrol.

**Note:** It is invalid to input the *0+CAM* keys in the current operation mode.



**Note:** Corresponding error message will appear on the screen when you perform wrong operation.

### 5.4.6 Setting a Pattern

Select the output monitor or window and the keyboard is capable of automatically connecting with its corresponding camera. Press the SET key on the keyboard and then press PATTERN key to enter the pattern settings interface. You are also allowed to directly select the camera and then press the SET key to start pattern settings.

- **Setting a Pattern by Output Channel**

**Steps:**

1. Press the *Num + MON* keys to select the output channel.
2. Press the *Num + WIN* keys to select the display window.
3. Press the *SET* key to enter the settings interface.
4. Press the *Num + PATTERN* keys to set the pattern number.
5. Operate the joystick to control PTZ movement.
6. Press the *SET* key again to finish the pattern settings.

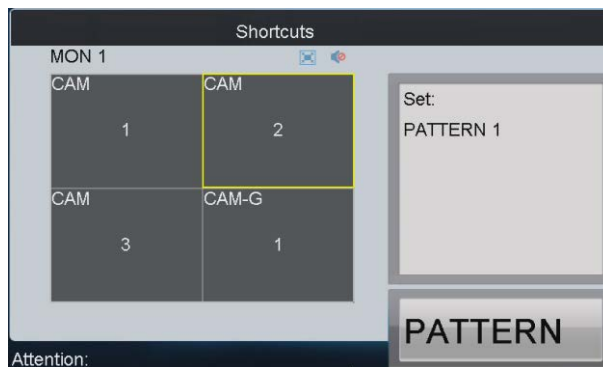

**Note:** It is invalid to input the *0+CAM* keys in the current operation mode.

- **Setting a Pattern by Input Channel**

**Steps:**

1. Press the *Num + CAM* keys to select the input channel.
2. Press the *SET* key to enter the settings interface.
3. Press the *Num + PATTERN* keys to set the pattern number.
4. Operate the joystick to control PTZ movement.
5. Press the *SET* key again to finish the pattern settings.

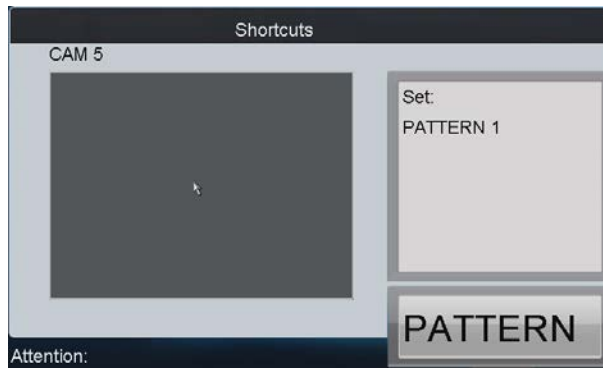

**Note:** Corresponding error message will appear on the screen when you perform wrong operation.

### 5.4.7 Calling a Pattern

Select the output monitor or window and the keyboard is capable of automatically connecting with its corresponding camera. Press the PATTERN key on the keyboard to call the programmed pattern. You are also allowed to directly select the camera by inputting Num + CAM keys and then press the PATTERN key to realize pattern callup.

- **Calling a Pattern by Output Channel**

**Steps:**

1. Press the Num + MON keys to select the output channel.
2. Press the Num + WIN keys to select the display window.
3. Press the Num + PATTERN keys to call the programmed pattern.

**Note:** This operation is valid only when the pattern function is supported by the connected camera/dome.

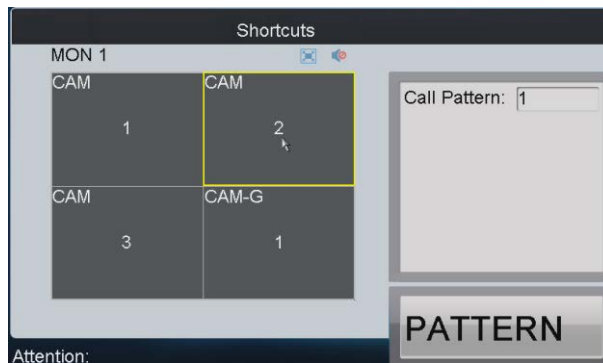

- **Calling a Pattern by Input Channel**

**Steps:**

1. Press the Num + CAM keys to select the input channel.
2. Press the Num + PATTERN keys to call the programmed pattern.

**Note:** It is invalid to input the 0+CAM keys in the current operation mode.





**Note:** Corresponding error message will appear on the screen when you perform wrong operation.

### 5.4.8 Calling Pan Scan

Select the output monitor or window and the keyboard is capable of automatically connecting with its corresponding camera. Press the **PATTERN** key on the keyboard to call the pan-scan. You are also allowed to directly select the camera by inputting Num + CAM keys and then press the **PATTERN** key to realize pan-scan callup.

- **Calling Pan-scan by Output Channel**

**Steps:**

1. Press the *Num + MON* keys to select the output channel.
2. Press the *Num + WIN* keys to select the display window.
3. Press the **PATTERN** key to call the pan-scan.
4. Press the **PATTERN** key again to stop the pan-scan.

**Note:** This operation is valid only when the pattern function is supported by the connected camera/dome.

- **Calling Pan-scan by Input Channel**

**Steps:**

1. Press the *Num + CAM* keys to select the input channel.
2. Press the **PATTERN** key to call the pan-scan.
3. Press the **PATTERN** key again to stop the pan-scan.

**Note:** It is invalid to input the *0+CAM* keys in the current operation mode.

**Note:** Corresponding error message will appear on the screen when you perform wrong operation.

## 5.5 Aux Functions

The keyboard is designed with AUX1 and AUX2 keys on its panel. You are allowed to configure Aux function for AUX1/AUX2 key on the operator user interface. By default settings, the AUX1 is selected to two-way audio and the AUX2 to picture capture function.

### 5.5.1 Two-way Audio

The two-way audio between the keyboard and the currently selected device can be realized through Aux key.

Start two-way audio with the output channel:

1. Press the *Num + MON* keys to select the output channel.
2. Press the *AUX1/AUX2* key to start two-way audio.

Start two-way audio with the input channel:

1. Press the *Num + CAM* keys to select the input channel.
2. Press the *AUX1/AUX2* key (configured with the Two-way Audio function) to start two-way audio.

During the two-way audio:

1. You can stop it by pressing the *0+AUX1/AUX2* keys;
2. When you input *Num + MON* keys and then presses the *AUX1/AUX2* key, it will switch the keyboard to take two-way audio with the nearest device;
3. If it needs to take two-way audio with the camera, it needs to press the ESC key, input the *Num + CAM* keys and then press the *AUX1/AUX2* key to start the two-way audio.

When the network is disconnected in the process of two-way audio, you should press the *0+AUX1/AUX2* keys to stop the two-way audio first and then start it again. When you intend to start the two-way audio between the keyboard and the remote device which is taking two-way audio with other device, the error message will appear on the screen.

**Note:** When the current window is configured with more than channels for display (in cycle view mode), the error message will appear on the screen as well.

### 5.5.2 Picture Capture

The video picture from the camera can be captured and saved in U-flash disk or uploaded to FTP server through the keyboard operation.

Operation method 1:

1. Press the *Num + MON* keys to select the output channel.
2. Press the *Num + WIN* keys to select the display window.
3. Press the *AUX1/AUX2* key (configured with the Picture Capture function) to start picture capture.

Operation method 2:

1. Press the *Num + CAM* keys to select the input channel.
2. Press the central button of the joystick.
3. The captured picture will be uploaded to FTP server (when FTP server is configured) or saved in the local U-flash disk.

**Note:** When the current window is configured with multiple channels for display (in cycle view mode), the error message will appear on the screen as well.

### 5.5.3 Recording

The video from the camera can be recorded and saved in the local U-flash disk or uploaded to FTP server as well.

Operation method 1:

1. Press the *Num + MON* keys to select the output channel.
2. Press the *Num + WIN* keys to select the display window.
3. Press the REC key to start video recording.

Operation method 2:

1. Press the *Num + CAM* keys to select the input channel.
2. Press the REC key to start video recording.

**Note:** During the recording, the REC key on the keyboard lights in red. When you exit the operation interface, the recording continues and you are allowed to stop it. When the window is configured with multiple channels for display (in cycle view mode), the error message will appear on the screen. And if the current window or output channel is performing playback by time, then the recording operation is not allowed.

### 5.5.4 Other Functions

The PREV and NEXT keys on the keyboard are used to select the previous or next camera during the shortcut operation.

Operation method 1:

1. Press the *Num + MON* keys to select the output channel.
2. Press the *Num + WIN* keys to select the display window.
3. Press the *PREV/NEXT* key to select the previous or next camera.

**Note:** If the current window is not in the dynamic decoding mode, it is invalid to press the *PREV/NEXT* key. When the window is configured with multiple channels for display (in cycle view mode), the error message will appear on the screen.

Operation method 2:

1. Press the *Num + CAM* keys to select the input channel.
2. Press the *PREV/NEXT* key to select the previous or next camera.

## Chapter 6 Server Operation

### 6.1 Control of MVC

Through the HBK-1100KI keyboard, you can configure and control the Multi-function Video Center (MVC).

#### 6.1.1 Login

**Steps:**

1. Click the **Server** icon on the startup interface to enter the **Server Login** interface.
2. Select the Login Mode to **MVC/Subdomain/Matrix Access Gate**.
3. On the Login interface, input the IP address, port, user name and password of the MVC.
4. Check the checkbox of **Remember Password** if you want to save the password for future login.

5. Click **Login** to enter the main interface of *admin*.

#### 6.1.2 Device List

After you have logged in the Matrix system, you can view the information of its functional modules on the MVC List interface.

Device Type	IP Address	Port	Set
M_DEC	192.0.0.73	8000	
M_DEC	172.9.122.101	8000	
M_DEC	172.9.122.102	8000	
M_DEC	172.9.122.103	8000	
M_DEC	172.9.122.104	8000	
M_DEC	172.9.122.105	8000	
M_DEC	172.9.122.106	8000	

The device types in the MVC system are shown as follows:

- M\_ENC**: Encoding module
- M\_DEC**: Decoding module
- M\_CODE**: Code distribution module
- M\_CAS\_IN**: Input cascading module
- M\_CAS\_OUT**: Output cascading module
- M\_INTEL**: Intelligent module
- M\_ALARM**: Alarm module
- V6\_DEC**: V6 decoding module
- V6\_CAS**: V6 cascading module
- MVC\_B10**: MVC B10
- MVC\_B11**: MVC B11
- MVC\_B12**: MVC B12
- M\_DS**: Domain system
- M\_SDS**: Sub-domain system
- MATRIX ACCESS GATEWAY**: Matrix access gateway

### Editing Device Parameters in Batch

By clicking the **Batch Edit IP** button, you can enter the Batch Edit interface to edit the parameters of the encoding/decoding modules, including the start IP, end IP, port, subnet mask and gateway.

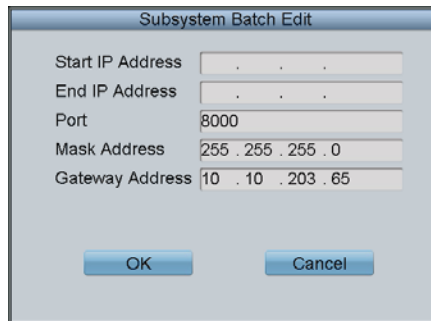

**Notes:**

- The range from the start IP to end IP must be larger than the number of the functional modules.
- When the NAT function of the system is enabled, it is not allowed to operate the batch edit.

### Configuring Encoder/Decoder Parameters

Click the  button of an encoder/decoder on the MVC List and enter its settings interface.

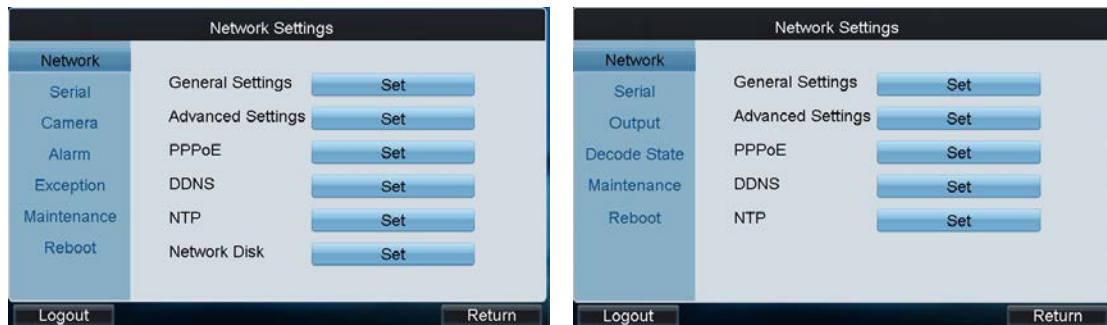

Please refer to the *Chapter 4.1 Encoder Settings*~ *Chapter 4.2 Decoder Settings* for details.

### 6.1.3 Camera List

#### Viewing Camera List

Click the **Camera** tab to view the information of all cameras connected to the current MVC system, including the camera ID, channel No., IP address and port. The No. is used as CAM number in the Shortcut Operation.

No.	Channel	Name	IP Address	Port
1	1	1	172.9.122.100	14600
2	2	2	172.9.122.100	14600
3	3	3	172.9.122.100	14600
4	4	4	172.9.122.100	14600
5	1	1	172.9.122.100	15300
6	2	2	172.9.122.100	15300
7	3	3	172.9.122.100	15300
8	4	4	172.9.122.100	15300

Total 48 items Page 1/6 To 1 P

#### Setting Input Group

**Steps:**

1. Click **Input Group** to enter the **MVC Input Group** interface.
2. Click  to select the group No. from the drop-down menu.
3. Set the Cycle Time (1-65535s) for the current group.

**Note:** The Cycle Time refers to the dwell time defined for each camera in this group.

MVC Input Group Add Camera

Group No. 1 Cycle Time 0 S Save

No.	Channel No.	IP Address	Port
-----	-------------	------------	------

Total 0 items Page 1/1 To 1 P

Delete Exit

4. Click the **Add Camera** key to enter the **Add Camera** interface:

Add Camera

Cycle Time 2 S

No.	Channel No.	IP Address	Port	
<input checked="" type="checkbox"/>	1	Camera 1	172.9.122.100	14600
<input checked="" type="checkbox"/>	2	Camera 2	172.9.122.100	14600
<input checked="" type="checkbox"/>	3	Camera 3	172.9.122.100	14600
<input checked="" type="checkbox"/>	4	Camera 4	172.9.122.100	14600
<input checked="" type="checkbox"/>	5	Camera 1	172.9.122.100	15300
<input checked="" type="checkbox"/>	6	Camera 2	172.9.122.100	15300
<input checked="" type="checkbox"/>	7	Camera 3	172.9.122.100	15300

Total 48 items Page 1/6 To 1 P

Add OK

5. Select the cameras from the list to be added to the group, and then click **Add** to add the selected cameras.

6. You can also set or edit the Cycle Time (1-65535s) for cameras here.
7. Click **Finish** to return to the **MVC Input Group** interface, where you can view the successfully added cameras for the current group.

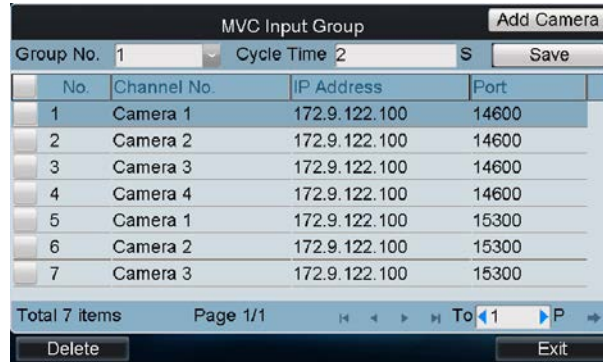

8. Click **Save** to save the settings.

## 6.1.4 Monitor List

### Viewing Monitor List

**Steps:**

1. Click the **Monitor** tab to view the information of all monitors connected to the current MVC system, including the monitor ID, output type, IP address and port.



2. Click the  button of a monitor from the list to enter the **Monitor Settings** interface.



3. Configuring monitor settings:

**Decoding Ability:** Set the parameters according to the resolution of the front-end device. If the maximum resolution of the front-end devices connected is 720P, then the Maximum Ability should be set as 720P.

**Output Type:** Configure the settings according to the mode that is supported by the monitor.

**Division Mode:** The standard-definition decoding module (BNC output) supports 1 / 4-division mode, while the high-definition decoding module (VGA / DVI / HDMI output) supports 1 / 4 / 9 / 16-division mode.

**Enable Audio:** To enable the audio output.

**Audio Window:** Select the window for enabling audio output.

4. After having finished the above settings, click **Save**.

**Quick Operation of Monitor Settings:**

1. Press the *Num + MON* keys to select the monitor.
2. Press the *Num + MULT* keys to select the window-division on the monitor.

Example: You can input the “2+MON, 16+MULT” keys to realize 16-divison display on monitor 2.

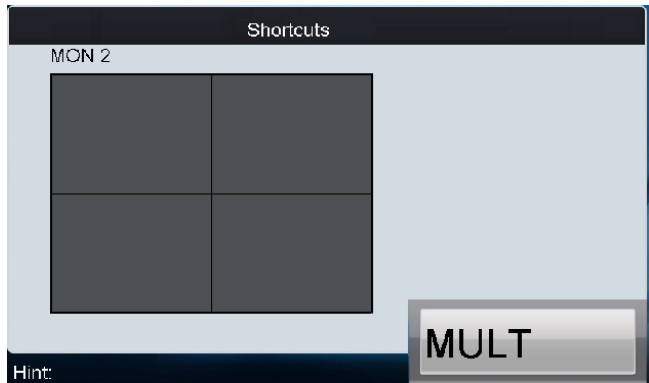

**Setting Output Group**

**Steps:**

1. Click **Output Group** to enter the **MVC Output Group** interface.
2. Click  to select the group No. from the drop-down menu.

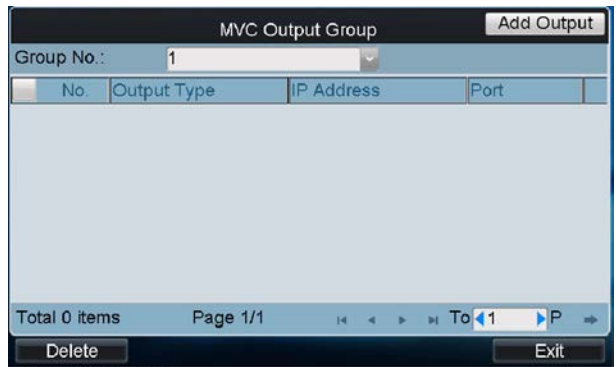

3. Click the **Add Output** key to enter the **Add Output** interface:

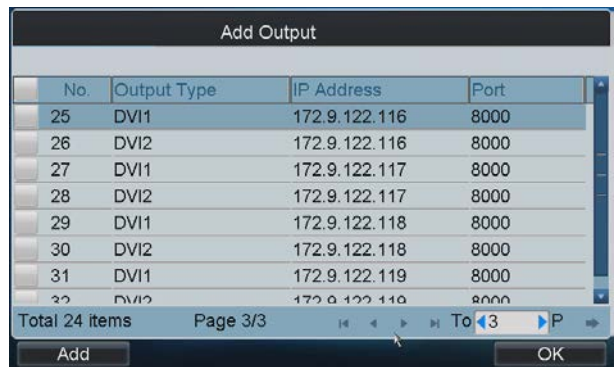

4. Select the outputs from the list to be added to the group, and then click **Add** to finish the setting.



- Click **OK** to return to the **MVC Output Group** interface, where you can view the successfully added output channels for the current group.

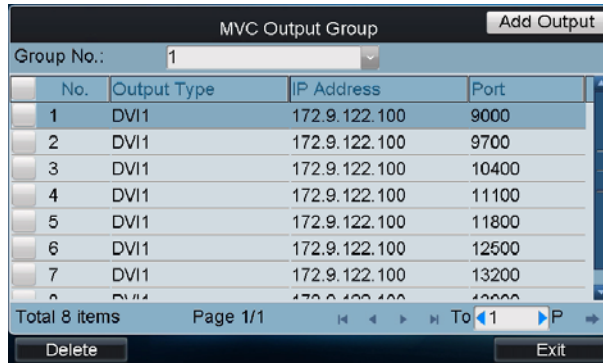

## Displaying Video on Monitor

The selected input signal can be outputted and displayed by the decoding channel on the monitor. Currently, the supported decoding resolution includes: QCIF, CIF, 2CIF, DCIF, 4CIF, 720p, 1080p, VGA, UXGA, etc. The output interface can be selected to BNC/VGA/HDMI/DVI.

### Task1: Local Live View

#### Steps:

- Press the *0+MON* to enter the local live view mode.
- Press the *Num + CAM* keys to enter the local live view of the selected camera.

### Task2: Display of Video on Monitor

#### Steps:

- Press the *Num + MON* keys to select the monitor.
- Press the *Num + WIN* keys to select the display window on the monitor.
- Press the *Num + CAM* keys to select the input camera.

Example: You can press the “*1+MON, 2+WIN, 3+CAM*” keys to decode the video signal from camera 3 and display it on window 2 of monitor 1.

When you press the *0+CAM* keys, it will stop the dynamic decoding of the current window. If no display window is selected, the decoding of the 1<sup>st</sup> window will be stopped by default.

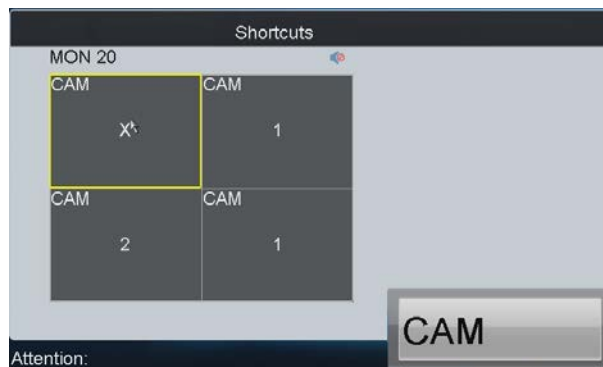

## 6.1.5 Scene Settings

#### Steps:

- Click the **Scene** tab to enter the Scene Settings interface.

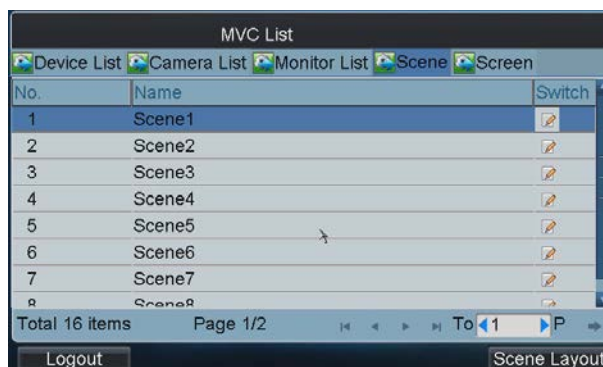

2. Click  on the list to switch to the selected scene.
3. Click the **Scene Layout** to enter the layout of the selected scene.

**Note:** The scene of MVC can be configured on the iVMS-4100 client software.



4. Click a grid to enter the following interface.

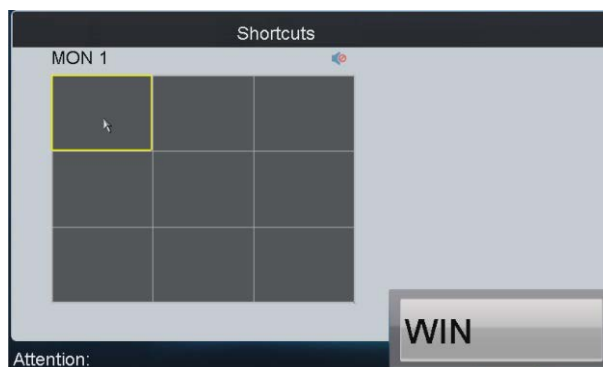

5. Press the *Num* + *WIN* keys or click on the window to select the window No.
6. Press the *Num* + *CAM* keys to select the camera No. of which the video is displayed on the selected window.



7. Repeat Step4~6 to configure the screen settings for the other windows of the scene.

## 6.1.6 Screen Settings

### Configuring Screen Settings

Click the **Screen** tab to configure video display on screen.



#### Steps:

1. Select the screen No..
2. Enable the screen display by clicking the checkbox.
3. Select the screen mode, e.g., 2 x 2.
4. Set the main screen No. which refers to the output for image processing.
5. Configure the sub-window settings.
  - (1) Select the sub-screen type to Standard, High Definition or Enhanced High Definition.
  - (2) Select the window, which refers to the sub-window No. of the screen. E.g., if the screen mode is selected to 2 x 2, then the sub-windows can be numbered as 1, 2, 3 and 4.
  - (3) Select the sub-screen No., which refers to the output connected to the selected sub-window in Step 5 (1).
- Note:** The Main Screen No. and the Sub-screen No. cannot be the same with each other.
- (4) Repeat the Step 5 (1) ~ (2) to set other sub-windows and their related sub-screen No.
- (5) Click **Save** to save the sub-window settings.
6. Click **Apply** to finish the screen settings.

### Configuring Video Output to Screen

You can follow the steps below to view the video from a camera on the selected screen.

#### Steps:

1. Press the *Num + AUX1* keys to select the screen.
2. Press the *Num + CAM* keys to select the input camera. The number of camera can be viewed from the Camera List.

Example: You can press the "1+AUX1, 3+CAM" keys to view the video signal from camera 3 on screen 1.

**Note:** The multi-division display mode is not supported by screen.



## Roaming Window Switch

### Steps:

1. Configure the Roaming settings in the iVMS-4100 client software.
2. Press the *Num + AUX1* keys to select the screen.
3. Press the *Num + WIN* keys to select the roaming layer of the screen.
4. Press the *Num + CAM* keys to select the input camera.

*Example:* You can press the "1+AUX1, 2+WIN, 3+CAM" keys to display the video signal from camera 3 on the roaming window 2 of multi-screen 1.

You can press the *0+CAM* keys, and it will stop the dynamic decoding of the current camera.

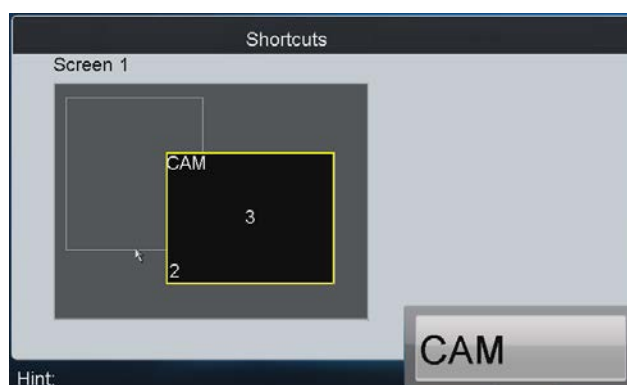

## Setting Base Picture

**Note:** When the MVC is configured with the enhanced decoder module, you can set the base picture for the screen display.

### Steps:

1. Put the base picture in the USB-flash disk and insert it into the keyboard.

**Note:** The base picture must be in JPEG format and with the resolution of lower than 3840×1920.

2. Enter the Screen settings interface.



3. Click the **Set Picture** button to enter the Setting Background Picture interface.

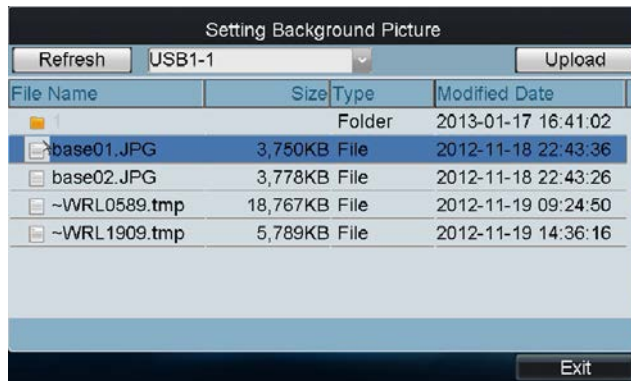

4. Select the picture file from the directory and click the **Upload** button to select the layer for the picture.

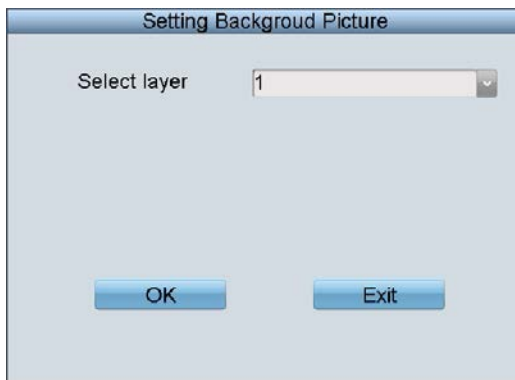

5. Select the layer from the drop-down list. Two base pictures can be uploaded.
6. Select **OK** to confirm the base picture settings.
7. On the screen settings interface, click the **Open Picture** button to select the layer and enable the configured base picture to be shown on the screen display.

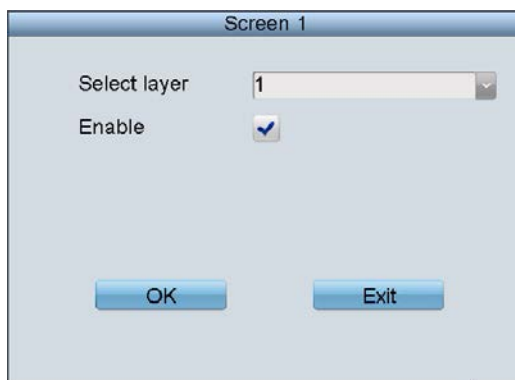

## 6.2 Control of Analog Matrix

### 6.2.1 Login

**Before you start:**

Make sure the analog matrix has been correctly connected to the keyboard before operation.

**Steps:**

1. Select the login mode to **Analog Matrix** on the **Server Login** interface.

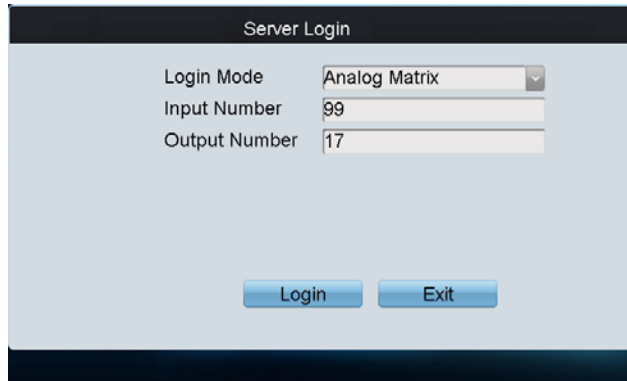

2. Enter the number of video inputs in the **Input Number** field.
3. Enter the number of video outputs in the **Output Number** field.
4. Click **Login** to log into the analog matrix system.

### 6.2.2 Configuring RS-232 Parameters

**Purpose:**

The RS-232 parameters must be configured the same with that of the connected analog matrix so as to realize the RS-232 communication.

**Before you start:**

Make sure the RS-232 port of analog matrix and the RS-232 port of keyboard have been connected with the control line.

**Steps:**

1. Click **RS232** on the Analog Matrix to enter the RS232 settings interface.

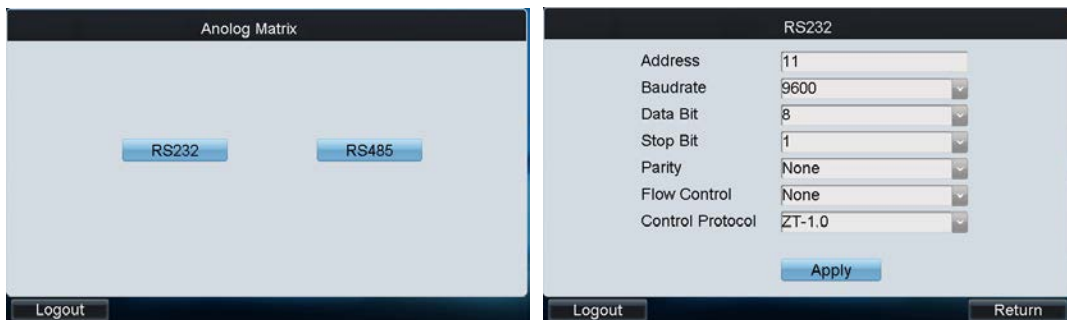

2. Input the address of the connected analog matrix. Each matrix must be assigned with unique address.
3. Select the baud rate of the connected analog matrix.
4. Set the data bit, stop bit, parity and flow control the same with those of the connected analog matrix.

5. Select the protocol of the connected analog matrix. Currently four protocols are supported: ZT-1.0, ZT-2.0, EXTRON and CREATOR.
6. Click **Apply** to save the settings.

### 6.2.3 Operating Analog Matrix

With successful RS-232 communication between the keyboard and the analog matrix, you can switch the video input to be displayed on the monitor by following the steps below.

**Steps:**

1. Press the *Num + MON* keys to select the output channel of the analog matrix.
2. Press the *Num + CAM* keys to select the input channel of the analog matrix.

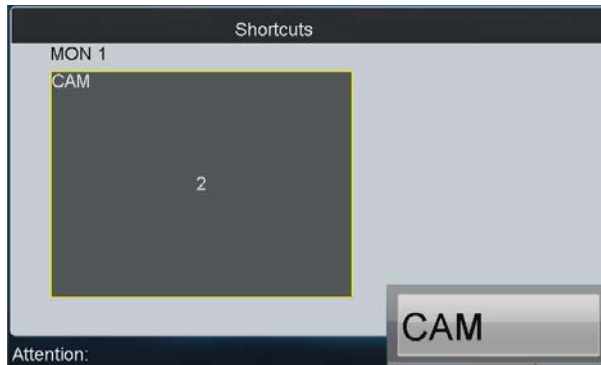

### 6.2.4 Configuring RS-485 Parameters

**Purpose:**

The RS-485 parameters must be configured the same with that of the connected PTZ camera so as to realize the PTZ control.

**Before you start:**

Make sure the R+ and R- terminals of the PTZ camera has been correctly connected to the T+ and T- terminals of the keyboard.

**Steps:**

1. Click **RS485** on the Analog Matrix to enter the RS485 settings interface.

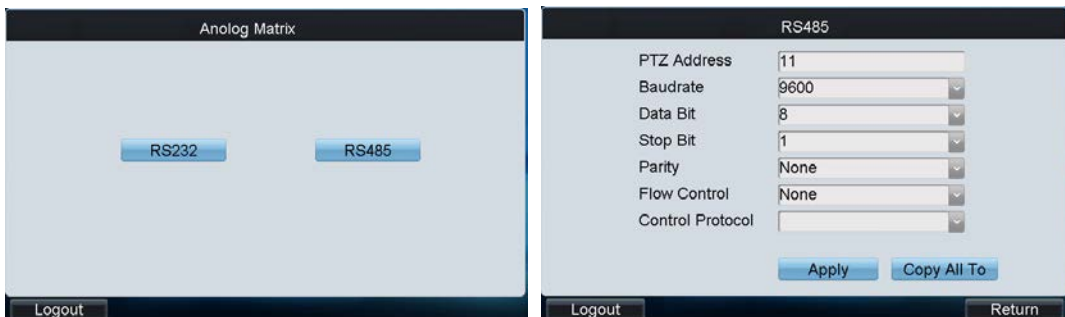

2. Input the address of the connected PTZ camera. The address ranges from 0~255.
3. Select the baud rate of the connected PTZ camera.
4. Set the data bit, stop bit, parity and flow control the same with those of the connected PTZ camera.
5. Select the protocol of the connected PTZ camera.
6. Click **Apply** to save the settings.

7. You can click the **Copy All To** button to copy the current RS-485 parameters to other PTZ addresses.

## 6.2.5 Operating PTZ Control

### Operating PTZ Movement

**Steps:**

1. Press the *Num + CAM* keys to select the connected analog dome or pan/tilt unit.  
**Note:** The Num must be the same as the PTZ address.
2. Move the joystick to realize the pan/tilt and lens movement.

### Setting/Calling a Preset

- **Setting a Preset**

**Steps:**

1. Input the *Num + CAM* keys to select the connected analog dome or pan/tilt unit.
2. Operate the joystick or focus/iris/zoom buttons to move PTZ to the desired position.
3. Input the *Num + PRESET* keys to set the current position as a preset.
4. Repeat step2 and step3 to continue to set the other presets.



- **Calling a Preset**

**Steps:**

1. Input the *Num + CAM* keys to select the connected analog dome or pan/tilt unit.
2. Input the *Num + CALL* keys to call the defined preset.

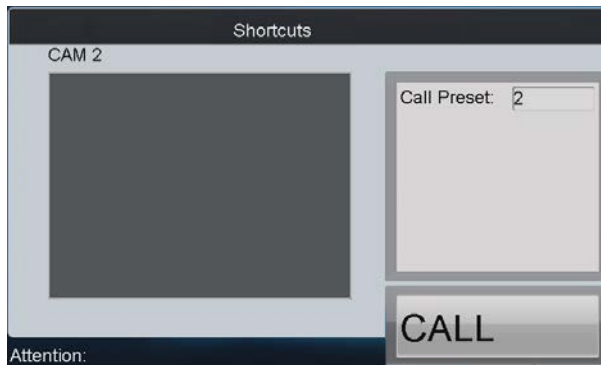



## Setting/Calling a Patrol

- **Setting a Patrol**

**Steps:**

1. Input the *Num + CAM* keys to select the connected analog dome or pan/tilt unit.
2. Press the *SET* key to enter the settings interface.
3. Press the *Num + PATROL* keys to enter the patrol settings interface.
4. Input Num and press the *ENTER* key to set the preset number, stop time and speed respectively.
5. Repeat Step4 to add other presets to the current patrol.
6. Press the *SET* key again to finish the patrol settings.



- **Calling a Patrol**

**Steps:**

1. Input the *Num + CAM* keys to select the connected analog dome or pan/tilt unit.
2. Input the *Num + PATROL* keys to call the defined patrol.

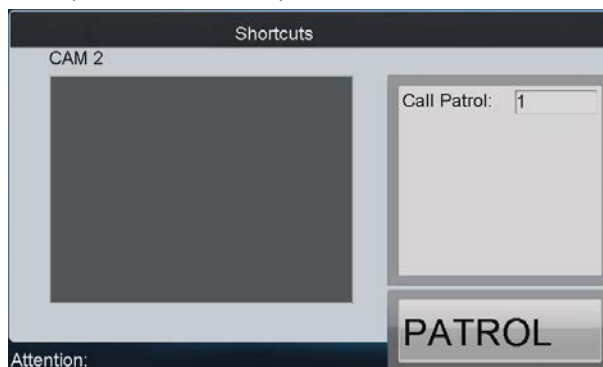

## Setting/Calling a Pattern

- **Setting a Pattern**

**Steps:**

1. Input the *Num + CAM* keys to select the connected analog dome or pan/tilt unit.
2. Press the *SET* key to enter the settings interface.
3. Press the *Num + PATTERN* keys to enter the pattern settings interface.
4. Operate the joystick or focus/iris/zoom buttons to move PTZ to record the pattern.
5. Press the *SET* key again to finish the pattern settings.



- **Calling a Pattern**

**Steps:**

1. Input the *Num + CAM* keys to select the connected analog dome or pan/tilt unit.
2. Input the *Num + PATTERN* keys to call the defined pattern.

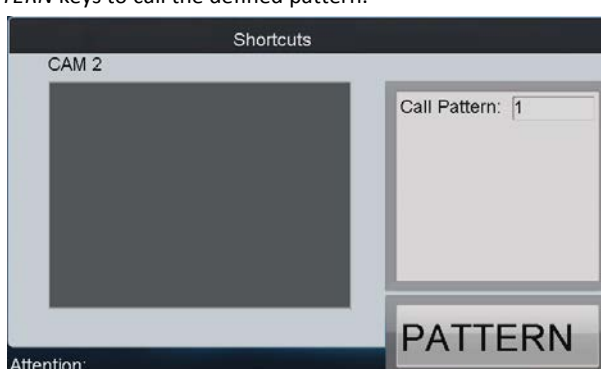

## 6.3 Access by iVMS Platform

The accessible iVMS platforms include: iVMS-5000, iVMS-7000 and iVMS-8200.

**Note:** Please make proper configuration on the iVMS platform before connecting the keyboard to the iVMS server.

Please refer to the user manual of corresponding iVMS platform for instructions.

### 6.3.1 Logging in to the iVMS Platform



**Steps:**

1. On the Server Login interface, select the Login Mode to iVMS Platform.
2. Enter the Server IP, Port, login User Name and Password.

- Click **Login** to log in to the platform.

The system enters the Control Center Unit List as shown below:

Control center unit list			
Search Item		Search	Scene
Index	Name	Type	Enter
2	AAA	Sub Control Cente	
3	BBB	Sub Control Cente	
1	A	Region	
2	B	Region	
120530034140073190	123	Screen Group	
112	109Channel1	Input	
12060404594398402	109Channel2	Input	

Total 7 items Page 1/1 To 1 P

Logout Refresh

### 6.3.2 Managing Output Channel

- Click on the list to edit the selected screen group.

tv-Screen Group		
Index	Name	Playback
5	Monitor:1	
4	Monitor:2	
3	Monitor:3	
2	Monitor:4	
1	Monitor:5	
100	Monitor:6	
102	Monitor:7	
103	Monitor:8	

Total 9 items Page 1/2 To 1 P

Logout Return

- Log in to the iVMS platform, and click **Organization->Monitor Screen Group** to enter the following page:

Organization							
Resource							
Monitor Screen Group							
Screen Group Name	Remote Operation	Proxy Server IP	Proxy Server Port	Decoding Resour...	Related Decoder Resources		
1 123	Layout	172.9.29.112	6666	1	108		

- Click **Layout** to enter the Screen Layout interface:

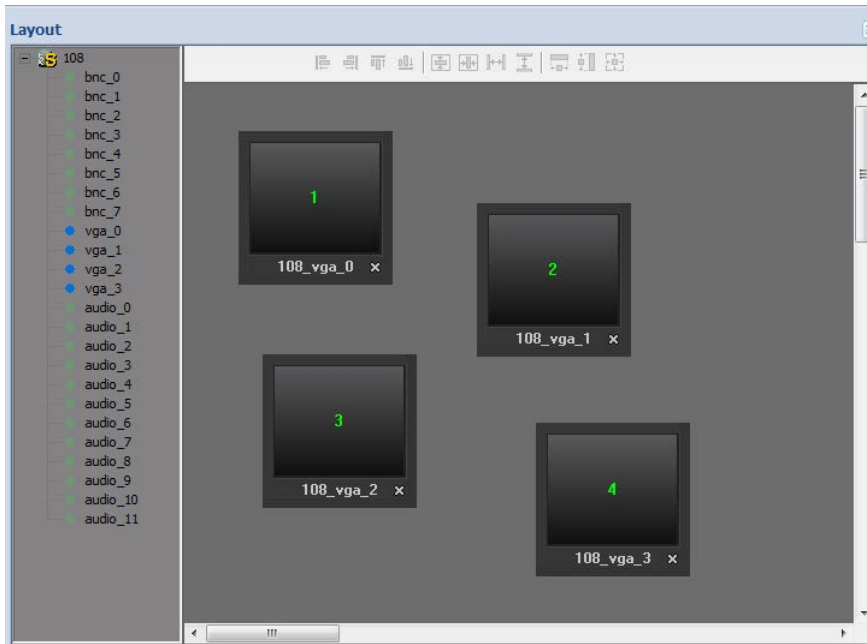

The corresponding output channel is corresponding to the Index No. on the Screen Group interface of the keyboard, e.g., the index 1 corresponds to the 108\_vga\_0 output channel.

4. Press the *Index No. + MON* keys (e.g., 1 + MON) on the keyboard to select the output channel.

### 6.3.3 Managing Input Channel

1. The corresponding input channel is corresponding to the Index No. on the Control Center Unit List interface of the keyboard, e.g., the index 12060404594398402 corresponds to the *Channel 1* of the device 109.

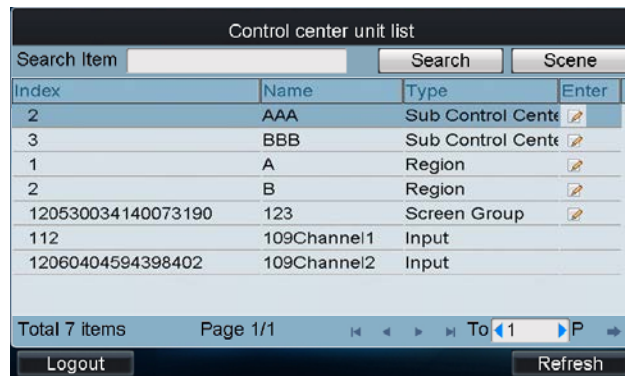

2. You can modify the index No. of the input channel via the iVMS platform.

Click **Organization->Camera** to enter the following page to view the list of connected input channels:

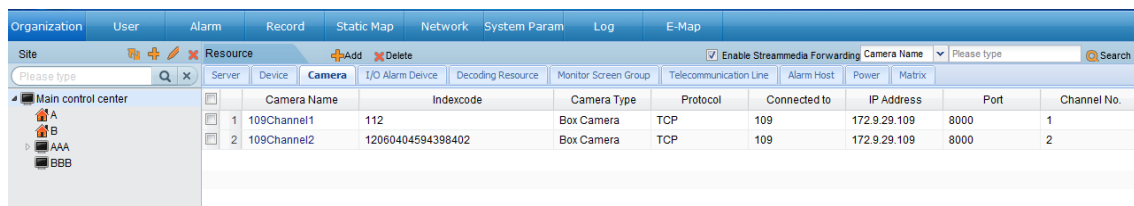

Select an input channel from the list and click it to enter the **Modify Camera** interface to modify the index No. in the **Indexcode** filed.

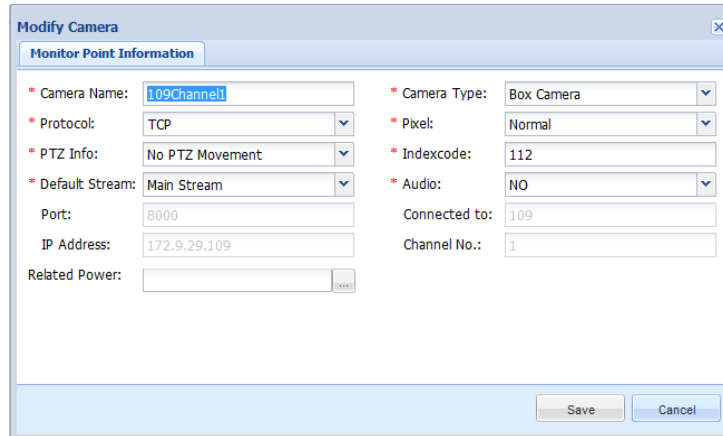

3. Press the *Index No.* + *CAM* keys (e.g., 1 + CAM) on the keyboard to select the input channel.

### 6.3.4 Local Live View

1. On the Control Center Unit List interface after login, click the  icon of a region item to enter the list of input channels added to this region.



2. Select an input channel and click the  icon to enter its local live view.

### 6.3.5 Displaying Video on Monitor

You can follow the steps below to view the video from a camera on the selected screen.

**Steps:**

1. Press the *Num* + *MON* keys on the keyboard to select the screen.
2. Press the *Num* + *WIN* keys on the keyboard to select the display window on the selected screen.  
**Note:** For the single-division display mode, this step is not needed; the window-division display mode must be configured via the iVMS platform.
3. Press the *Num* + *CAM* keys on the keyboard to select the input channel for display on the selected window.

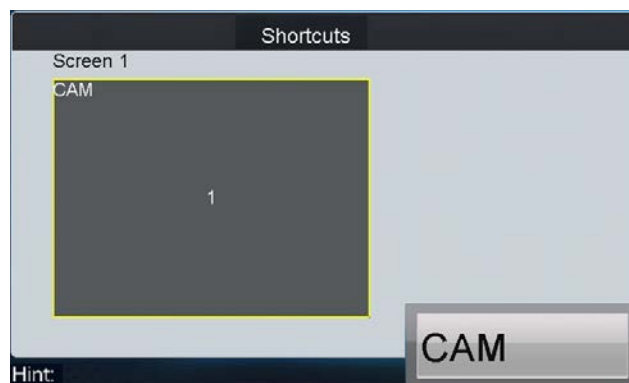

### 6.3.6 Playback

1. On the Control Center Unit List interface after login, click the  icon of a screen group item to enter the list of output channels.

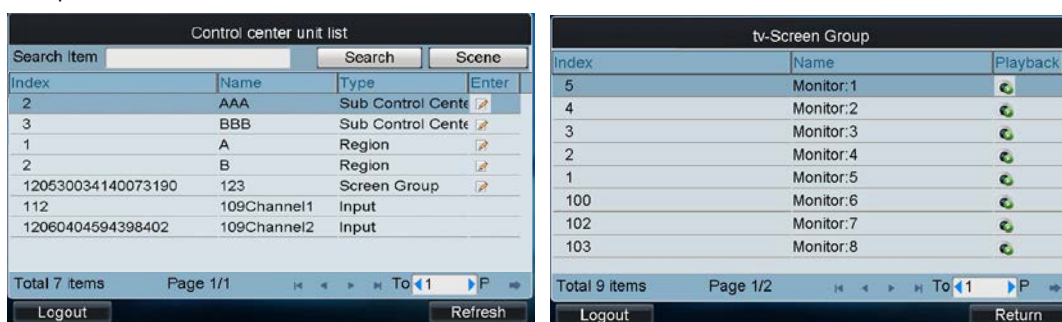

2. Select an output channel and click the  icon to enter the playback interface:



3. Select the camera No. for playback.
4. Select the location of record files to Device Record, NVR Record or CVR Record.
5. Select the record type.
6. Set the date of the record files.
7. Click **Search** to enter the playback by time interface.
8. Select the output channel and set the time.
9. Click **Playback** to enter the playback interface.
10. Select the sub window and start playing back.

# Chapter 7 Keyboard Configuration by WEB Server

You are also allowed to configure the keyboard parameters by WEB server.

## 7.1 Configuring by *Admin*

### 7.1.1 Login

Open WEB browser, input the IP address of the keyboard (e.g., <http://172.6.24.64>) and click Enter.

The system pops up a login interface. Input the user name (admin) and password (default: 12345), and then click **OK** to log into the keyboard.

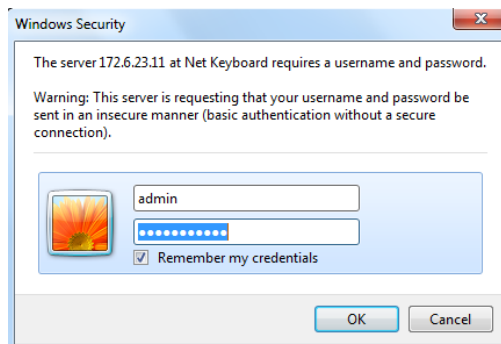

After successful login, you enter the main interface:

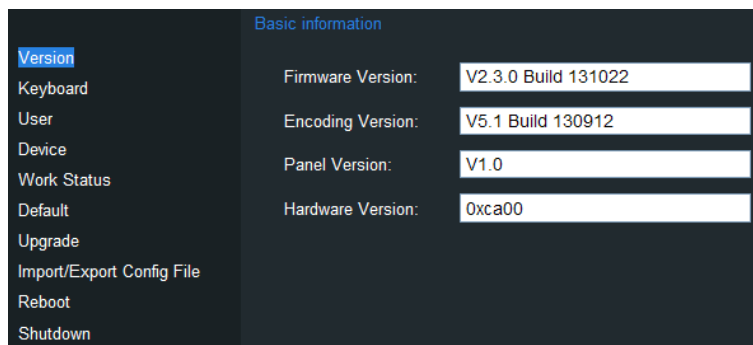

### 7.1.2 Keyboard Management

Click **Keyboard** on the left navigation bar to enter the Keyboard management interface:

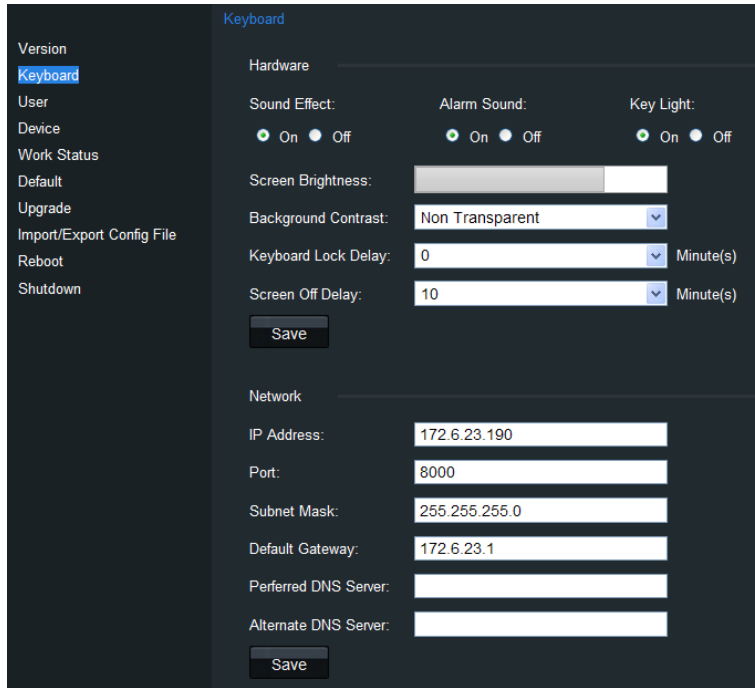

On this interface, you can configure the hardware and network parameters of the keyboard.

### 7.1.3 User Management

Click **User** on the left navigation bar to enter the User management interface:



On this interface, you can add, edit or delete the user account.

#### Adding a User

Click the **Add** button to enter the Add Users interface. Input the user name and password to create a new user account.

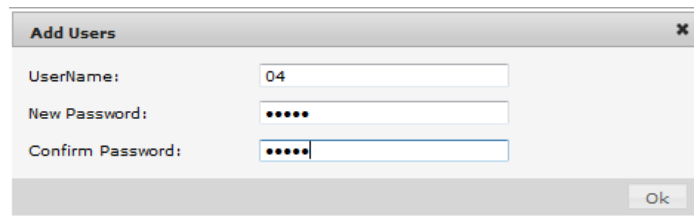

#### Editing a User

Select a user from the list and click the  icon to enter the following interface to change its password.



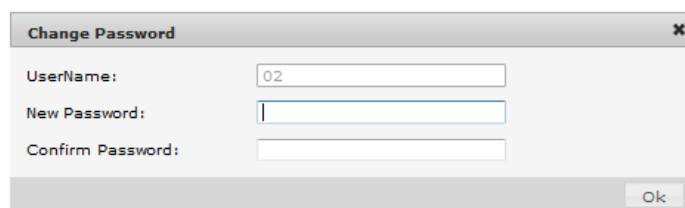

**Change Password**

UserName:

New Password:

Confirm Password:

Ok

### Deleting a User

Select a user from the list and click the  icon. In the pop-up message box, click **OK** to delete the selected user account.

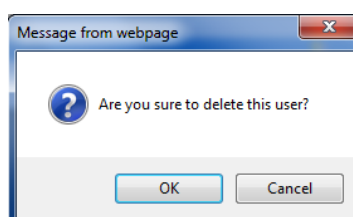

Message from webpage

Are you sure to delete this user?

OK Cancel

### Setting User-Device

Select a user from the list and click the  button to enter the User-Device interface.

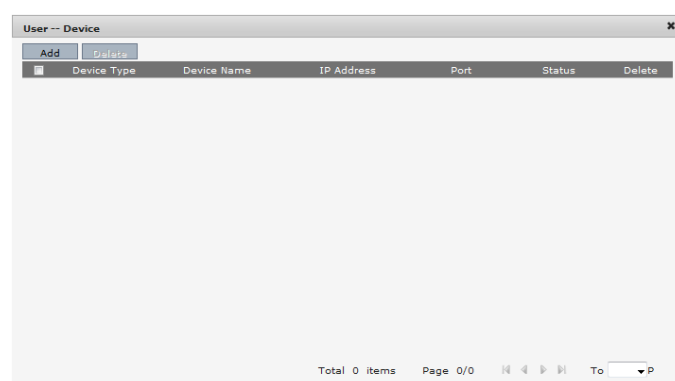

User -- Device

Add Delete

Device Type	Device Name	IP Address	Port	Status	Delete
Total 0 items Page 0/0					





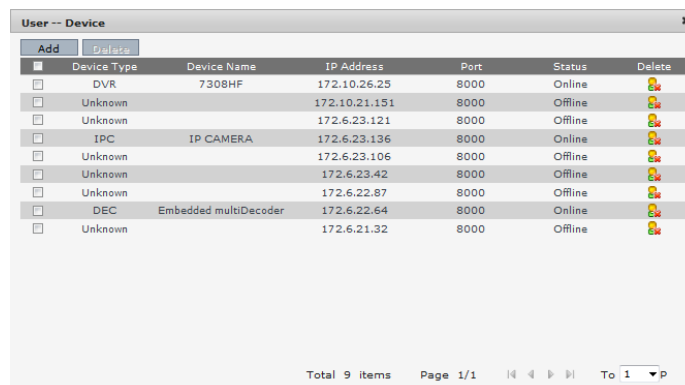



On this interface, you can add device for the current user.

Click **Add** to enter the User-Add Device interface on which it displays all devices already added to the keyboard by *admin*.



User -- Device

Add Delete

Device Type	Device Name	IP Address	Port	Status	Delete	
<input type="checkbox"/>	DVR	7308HF	172.10.26.25	8000	Online	
<input type="checkbox"/>	Unknown	7308HF	172.10.21.151	8000	Offline	
<input type="checkbox"/>	Unknown	7308HF	172.6.23.121	8000	Offline	
<input type="checkbox"/>	IPC	IP CAMERA	172.6.23.136	8000	Online	
<input type="checkbox"/>	Unknown	7308HF	172.6.23.106	8000	Offline	
<input type="checkbox"/>	Unknown	7308HF	172.6.23.42	8000	Offline	
<input type="checkbox"/>	Unknown	7308HF	172.6.22.87	8000	Offline	
<input type="checkbox"/>	DEC	Embedded multiDecoder	172.6.22.64	8000	Online	
<input type="checkbox"/>	Unknown	7308HF	172.6.21.32	8000	Offline	

Total 9 items Page 1/1

Select the device (s) from the list and then click **Add** button to finish the adding of device (s) for the current user.

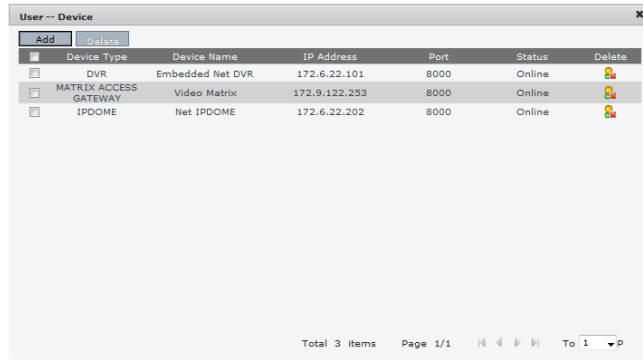

On the User-Device interface, you can view the successfully added devices for the current user.

You can also select the device from the list and click the icon to delete it.

### 7.1.4 Device Management

Click **Device** on the left navigation bar to enter the Device management interface:

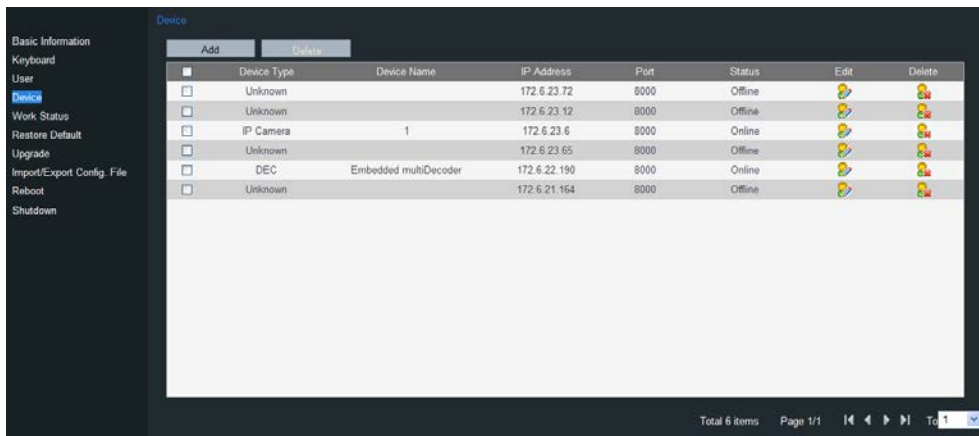

On this interface, you can add, edit or delete the device.

#### Adding a Device

Click **Add** to enter the Add User interface. Input the name, IP, port and login user name/password of the device to add.

Click **OK** to finish the adding of the device.

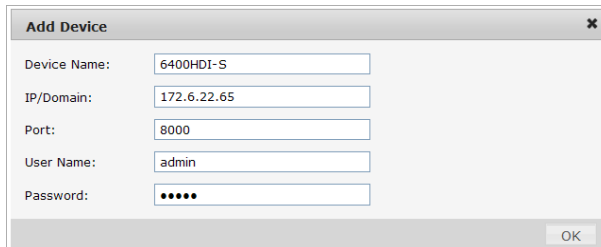

The successfully added devices will be displayed on the list of Device Interface.

#### Editing a Device

Select a device from the list and click the icon to enter the following interface to change its Device Name.

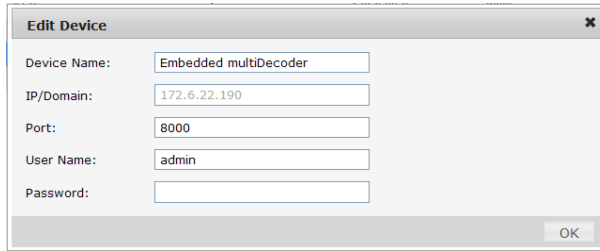

**Deleting a Device**

Select a device from the list and click the  icon to delete it.

**7.1.5 Maintenance**

**Checking Device Work Status**

Click the **Work Status** on the left navigation bar to check the work status of the keyboard.

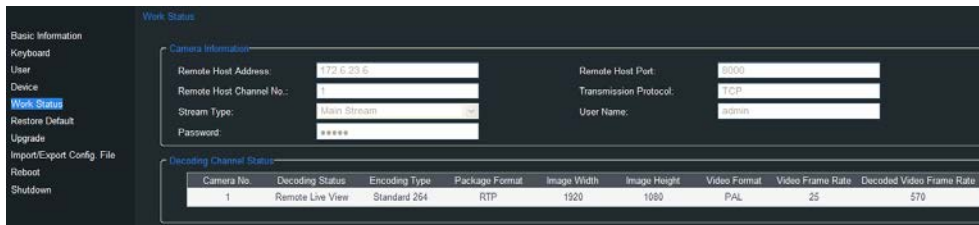

**Restoring Default**

Click the **Restore Default** on the left navigation bar to enter the default interface.

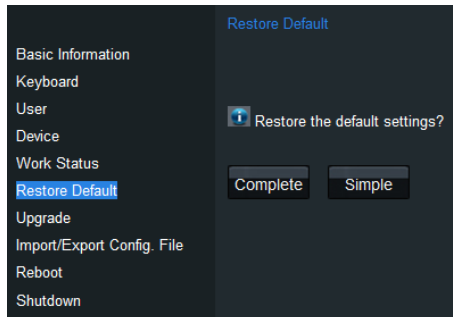

Select the default type on your demand, Complete and Simple are selectable.

Please refer to 3.5 *Default* for the details of two default types.

**Import/Export Configuration File**

Click the **Import/Export Config. File** on the left navigation bar to enter the configuration file management interface.

**Note:** For the first time use of the import/export configuration file function, a plug-in needs to be installed. A hint will appear on the lower-half of the screen:” Please click here to download and install the plug-in. Close the browser when installing the plug-in.” Click the hint and follow the pop-up instruction to install the plug-in.

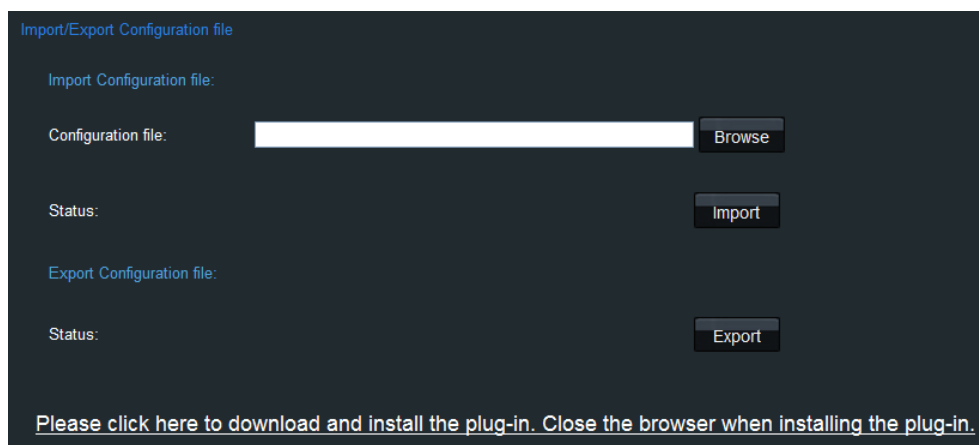

To import the configuration file, click the **Browse** button and specify the directory of the file in the pop-up box, and click the **Import** button.

To export the configuration file, click the **Export** button and specify the saving directory of the exported file.

### Upgrade

Click the **Upgrade** on the left navigation bar to enter the upgrade interface.

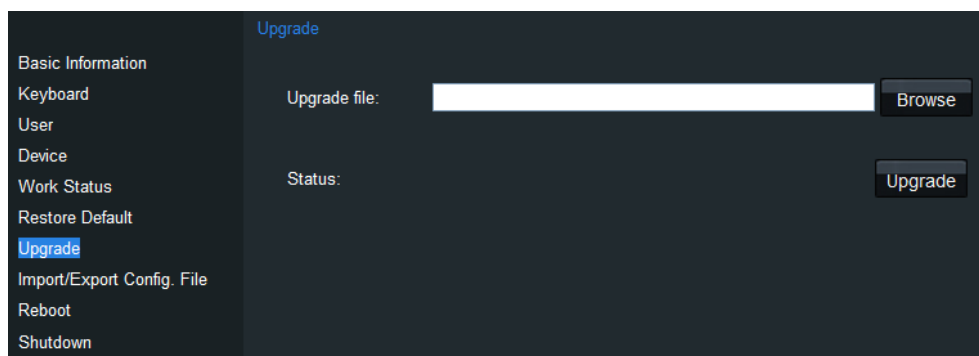

Click the **Browse** to select the upgrade file directory in the pop-up box.

Click the **Upgrade** button.

## 7.2 Configuring by Operator

### 7.2.1 Device List

On the login interface, input the user name and password of *operator*, and then click **OK** to log into the keyboard.

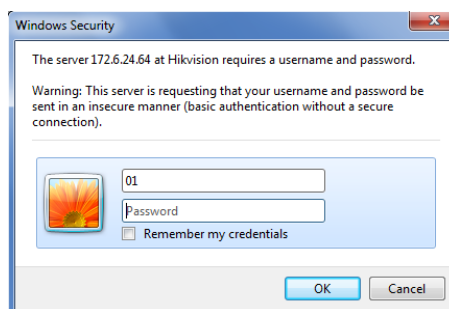

After successful login, you enter the Device List interface:

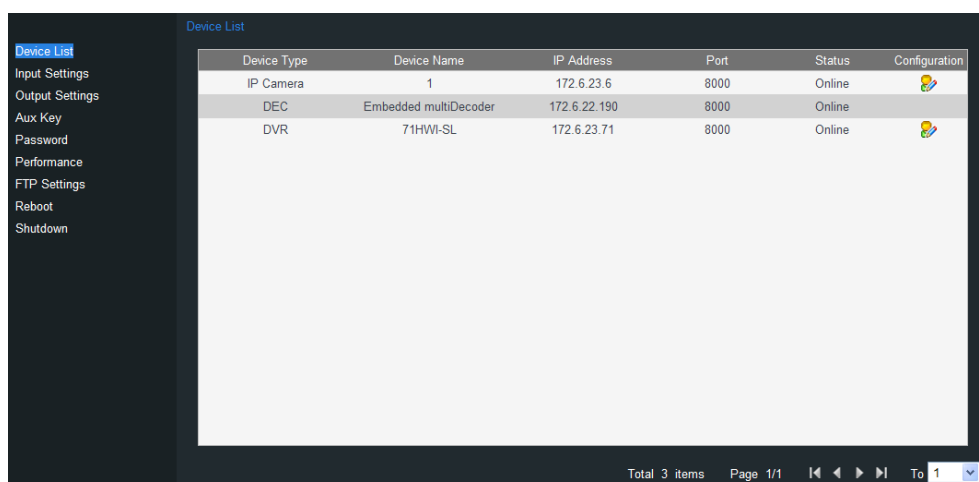

On the device list, select an encoding device and click the icon to enter the Network-Stream media interface to configure stream media for the device.

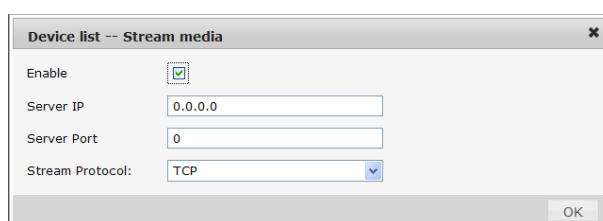

## 7.2.2 Input Settings

Click **Input Settings** on the left navigation bar to enter the Input List interface:

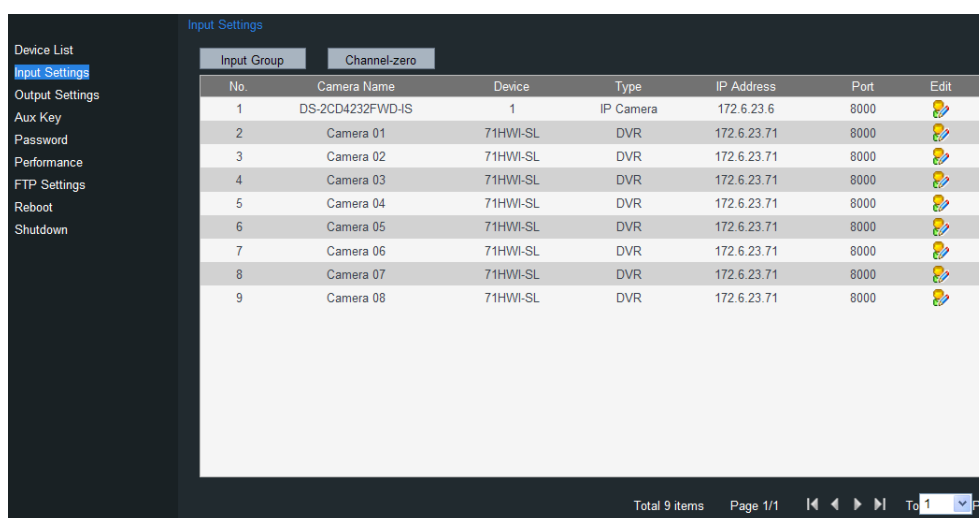

### Editing a Camera

By selecting a camera from the list and clicking the icon, you are allowed to edit its name, No., protocol and stream type.

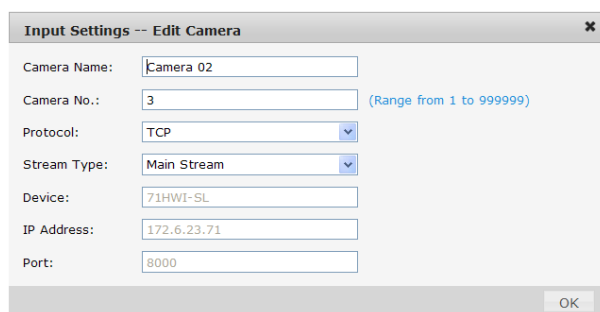

### Setting a Camera Group

1. Click the **Group** button on the Input List to enter the Input Group interface:

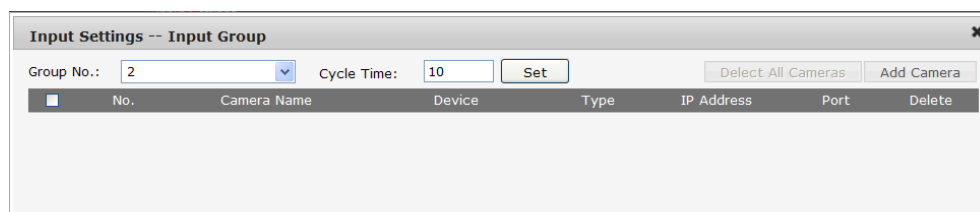

2. Select the Group No. and edit the cycle time in the given text filed, and click **Set** button.
3. Click the **Add Camera** key to enter the Add Camera interface:
4. Select the cameras from the list to be added to the group, and then click **Add** to finish the setting.

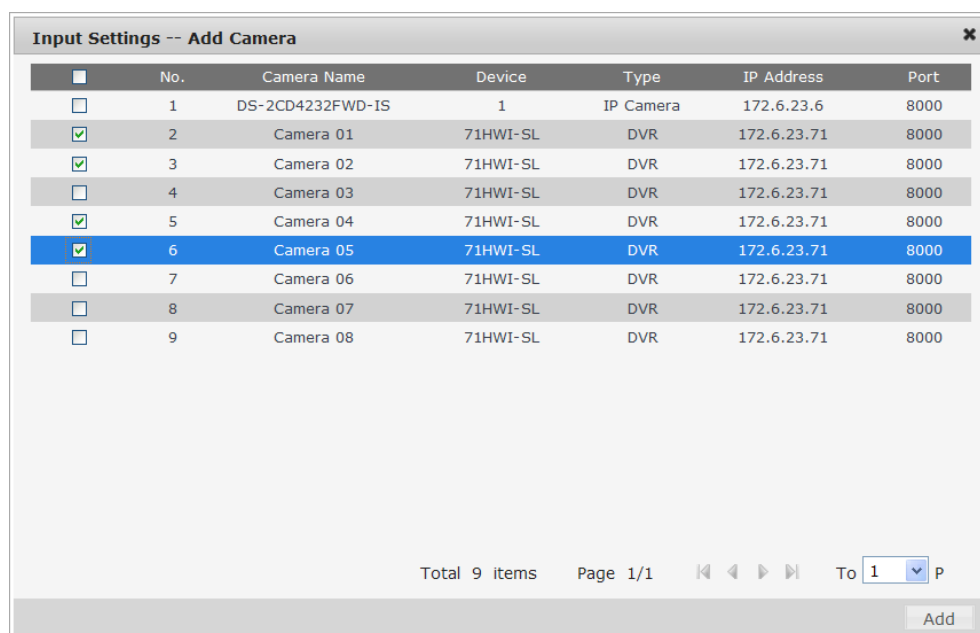

5. Return to the Input Group interface, and you can view the successfully added cameras for the current group.

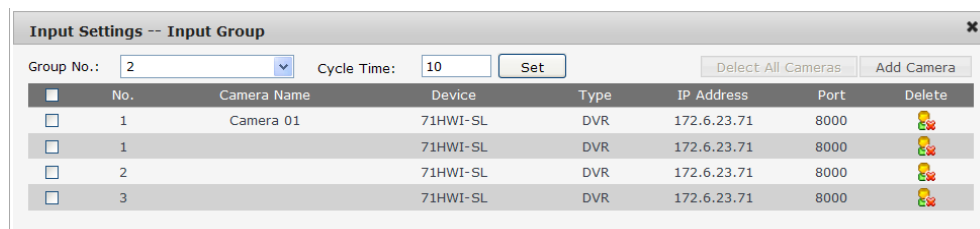

### Viewing Channel-zero

Click the **Channel-zero** button to show the list of device which support the Channel-zero function.

Device	Device Type	IP Address	Port
Embedded Net DVR	DVR	172.6.23.71	8000
Embedded Net DVR	DVR	172.6.23.65	8000

Total 2 items Page 1/1

### 7.2.3 Output List

Click **Output Settings** on the left navigation bar to enter the Output List interface:

No.	Output Type	Device	Type	IP Address	Port	Edit
1	VGA1	Embedded multiDecoder	DEC	172.6.22.190	8000	
2	VGA2	Embedded multiDecoder	DEC	172.6.22.190	8000	
3	VGA3	Embedded multiDecoder	DEC	172.6.22.190	8000	
4	VGA4	Embedded multiDecoder	DEC	172.6.22.190	8000	
5	VGA5	Embedded multiDecoder	DEC	172.6.22.190	8000	
6	VGA6	Embedded multiDecoder	DEC	172.6.22.190	8000	
7	VGA7	Embedded multiDecoder	DEC	172.6.22.190	8000	
8	VGA8	Embedded multiDecoder	DEC	172.6.22.190	8000	
9	BNC1	Embedded multiDecoder	DEC	172.6.22.190	8000	
10	BNC2	Embedded multiDecoder	DEC	172.6.22.190	8000	
11	BNC3	Embedded multiDecoder	DEC	172.6.22.190	8000	
12	BNC4	Embedded multiDecoder	DEC	172.6.22.190	8000	
13	HDMI1	Embedded multiDecoder	DEC	172.6.22.190	8000	
14	HDMI2	Embedded multiDecoder	DEC	172.6.22.190	8000	
15	HDMI3	Embedded multiDecoder	DEC	172.6.22.190	8000	
16	HDMI4	Embedded multiDecoder	DEC	172.6.22.190	8000	

Total 20 items Page 1/2

#### Editing an Output Channel

By selecting an output channel from the list and clicking the icon, you are allowed to edit its output No..

Output No.:	<input type="text" value="1"/>	(Range from 1 to 999999)
Output Type:	<input type="text" value="VGA1"/>	
Device:	<input type="text" value="Embedded multiDecoder"/>	
IP Address:	<input type="text" value="172.6.22.190"/>	
Port:	<input type="text" value="8000"/>	
<input type="button" value="OK"/>		

#### Setting an Output Group

Click the **Output Group** key on the Output List to enter the Output Group interface to add an output group. Please refer to the same operating steps in *Setting an Input Group* section.

#### Setting Video Wall/Scene

Click the **Video Wall/Scene** button on the Output List to enter the video wall / scene setting interface.

No.	Name	Device Name	IP Address	Port	Edit
1	Video Wall 01	Embedded multiDecoder	172.6.22.190	8000	
2	Video Wall 02	Embedded multiDecoder	172.6.22.190	8000	
3	Video Wall 03	Embedded multiDecoder	172.6.22.190	8000	
4	Video Wall 04	Embedded multiDecoder	172.6.22.190	8000	

Total 4 items Page 1/1 To 1 P

Click the icon to edit the video wall / scene No..

### 7.2.4 AUX Functions

Click the **Aux Key** on the left navigation bar to enter the Aux Key settings interface:

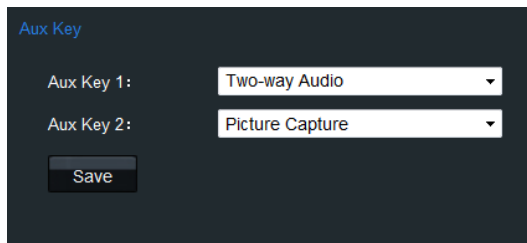

On this interface, you can set the function of Aux Key 1 / Aux Key 2 to two-way audio, picture capture, or video wall/scene switch.

### 7.2.5 Live View & PTZ Speed Settings

Click **Performance** on the left navigation bar to enter the network performance and PTZ speed settings interface.

It allows you set the network performance of local live view on keyboard. Five levels are selectable.

You can also set the PTZ movement speed of the connected PTZ camera by using the joystick. Four levels are selectable.

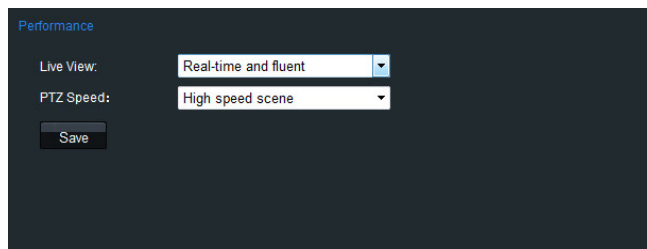

### 7.2.6 FTP Server Settings

The video files or captured pictures can be uploaded to FTP server.

**Steps:**

1. Click **Ftp Setting** on the left navigation bar to enter the FTP settings interface.



FTP SETTING

Enable FTP:

IP: 172.6.23.11

Username: test

Password: ●●●●●

File Path: g:\pic

Save

2. Check the checkbox of **Enable FTP**.
3. Enter the IP address of the FTP server.
4. Enter the user name and password of login to the FTP server.
5. Enter the file path to which the video files and captured pictures are uploaded.
6. Click **Save** to save the settings.

## Chapter 8 Keyboard Configuration Tool

### **Purpose:**

The configuration tool of the HBK-1100KI keyboard is used to facilitate the parameters configuration of the keyboard.

### 8.1 System Requirements

System requirement: 32-bit Windows XP / Windows 7.

Running conditions: please place the application program in the same directory where the *HCNetSDK.dll*, *hpr.dll*, and *Sadp.dll* files locate. If the *SADP* software is not useable, please install the *WinPcap\_4\_1\_2.exe* first.

### 8.2 Features

The following functions can be realized by operating the keyboard configuration tool:

- Add/Edit/Delete the user account.
- Add/Edit/Delete the device under the *Administrator*.
- Add/Delete the device under the *Operator*.
- Link the device to stream media server in single/batch mode.
- Delete the channel under the *Operator*.
- Save channel information of the user to local directory in text document.
- Import/Export the configuration file.
- Export the input/output list as the *.txt* file.
- Upgrade the keyboard.

### 8.3 Selecting Login Mode to Configuration Tool

Run the application program to enter the following interface:



Select the mode for configuration. Three modes are selectable: Local Config File, Remote Config File and Update Keyboard.

- **Local Config File:** Use and edit the configuration file of the keyboard which has been exported to PC or local

storage device via U-flash disk.

- **Remote Config File:** Operate and edit the configuration file of the keyboard which has been exported to PC or local storage device via network.
- **Update Keyboard:** Upgrade the keyboard via network.

### 8.3.1 Login by Local Configuration File

#### Before you start

Make sure the configuration file (*kbCfg.bin*) of the keyboard has been exported to your PC or local storage device.

Please refer to *Chapter 3.4.4 Importing/Exporting Configuration File* for exporting the config file.

#### Steps:

1. Click **Local Config File** icon to enter the following Login interface:

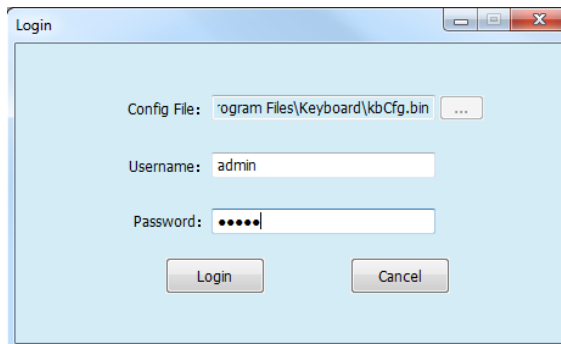

2. Click  to select the destination directory of the Config File from your PC or local storage device.

**Note:** The Config File must be in *kbCfg* format.

3. Input the admin and password for login.
4. Click **Login**.

The configuration file will be backed up in the *backup* folder by default. If the file has already existed in the *backup* destination folder, corresponding message box will pop up. Click **OK** to replace the existing file, or **Cancel** to keep the original file.

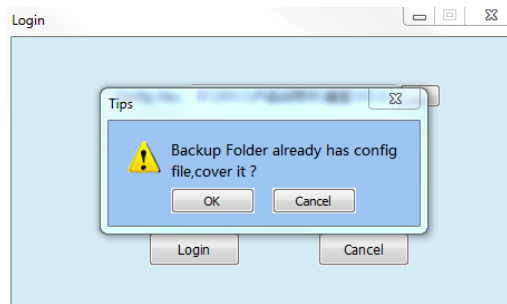

### 8.3.2 Export/Login by Remote Configuration File

#### Steps:

1. Click **Remote Config File** icon on the Mode Choose interface to enter the Config File interface.

2. Click  to select the saving directory for the configure file.
3. Input the IP address and port number of the keyboard.
4. Input the user name and password for login to the keyboard.
5. Click **Export** to export the keyboard configure file to the defined directory, or click **Export&login** to export log in the software.

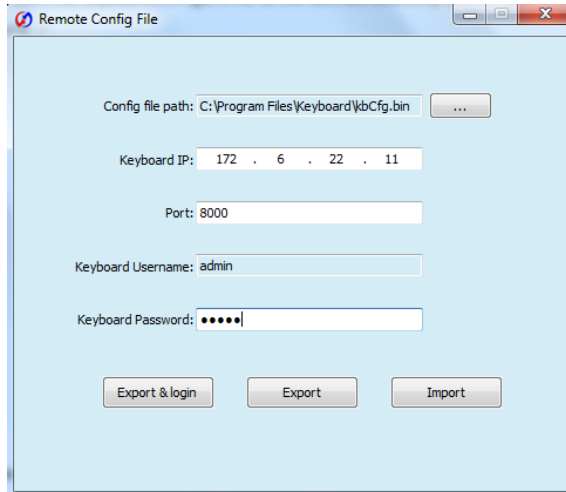



6. On the Login interface, select the configure file directory, and input the user name and password for login. Refer to Step2-4 in 6.3.1 *Logging in to the iVMS Platform*.
7. After successful login, you will enter the main interface.

### 8.3.3 Remote Upgrade

**Steps:**

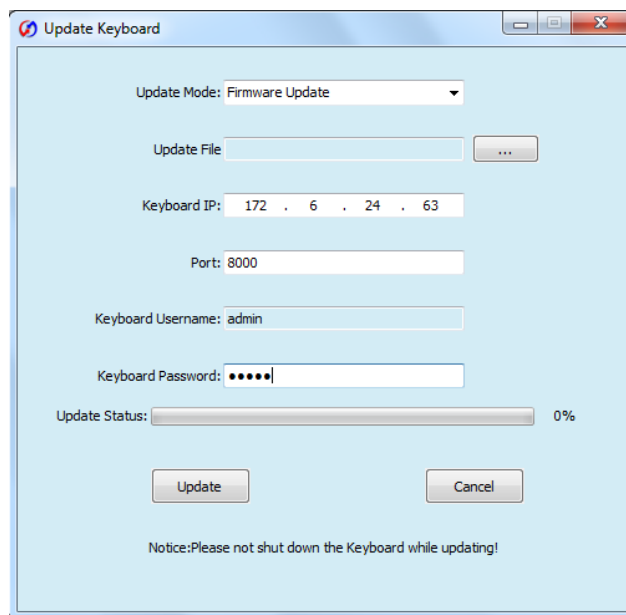
1. Click **Upgrade Keyboard** icon on the Mode Choose interface to enter the Remote Upgrade interface.



2. Select the Update Mode to Firmware Update.
3. Click  to select the update file from the local disk.

4. Input the IP address and port number of the keyboard.
5. Input the user name and password for login to the keyboard.
6. Click **Update** to start upgrading the keyboard. The upgrading process can be viewed on the Status bar.

**Note:** Please do not shut down the keyboard when the upgrading is not finished.

## 8.4 Configuring Keyboard by Configuration Tool

### 8.4.1 Managing Device List

After successful login by Local File or Remote File mode, you can enter the following interface:

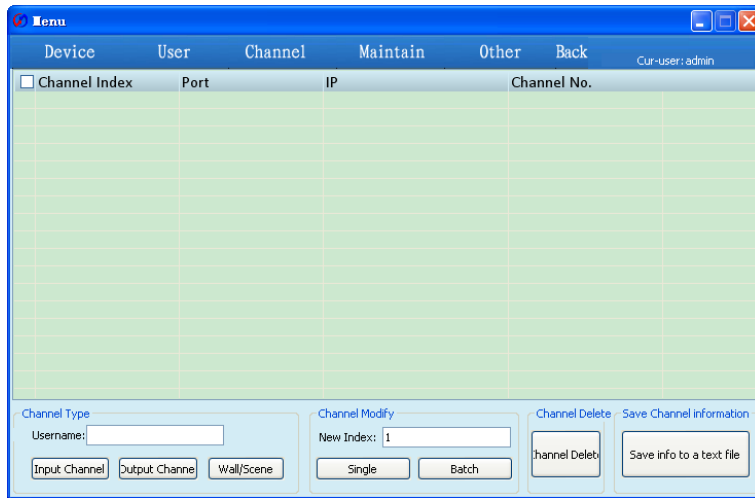

Click the **Device** on the menu bar to enter the Device Management interface:

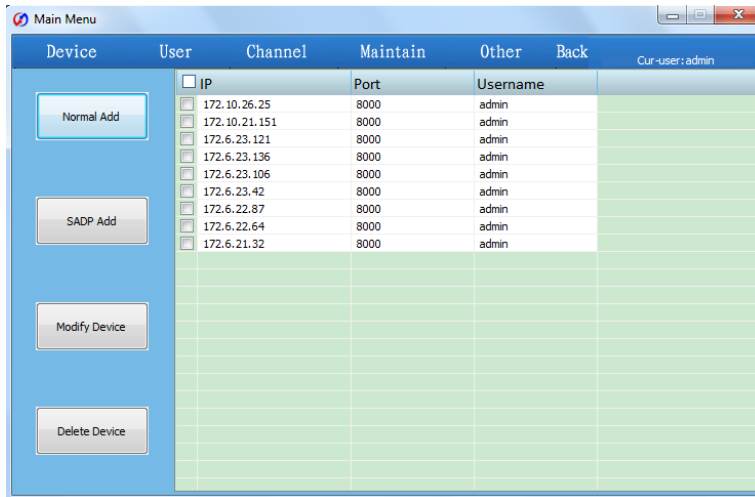

### Adding a Device

You can add a device by manually or by SADP software.

**Normal Mode:**

1. Click  to enter the **Add Devices** interface.

2. Select the Type to Single or Batch.

**Single IP:** add single device each time.

**Batch IP:** add multiple devices located in the same network segment.

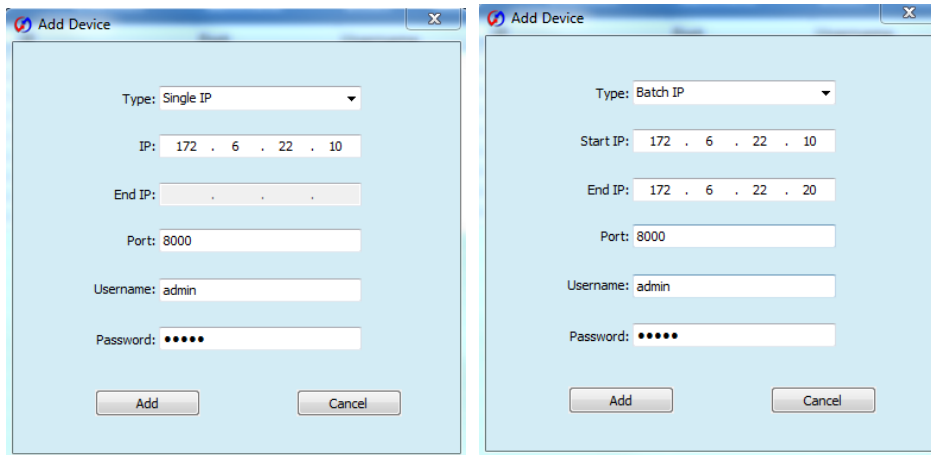

3. Enter the device IP for **Single IP** mode, or the Start IP and the End IP for the **Batch IP** mode.

**Note:** The start IP and the end IP must be within the same network segment.

4. Enter the Username and Password for login.
5. Click **Add** to add the device (s).

**SADP Mode:**

You can use the SADP software to automatically search and add the online devices in the same network.

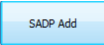
1. Click  to enter the **Search online devices** interface.
2. The automatically searched devices will be displayed on the list. Select a device from the list and click **Add** to enter the **Add Devices** interface.

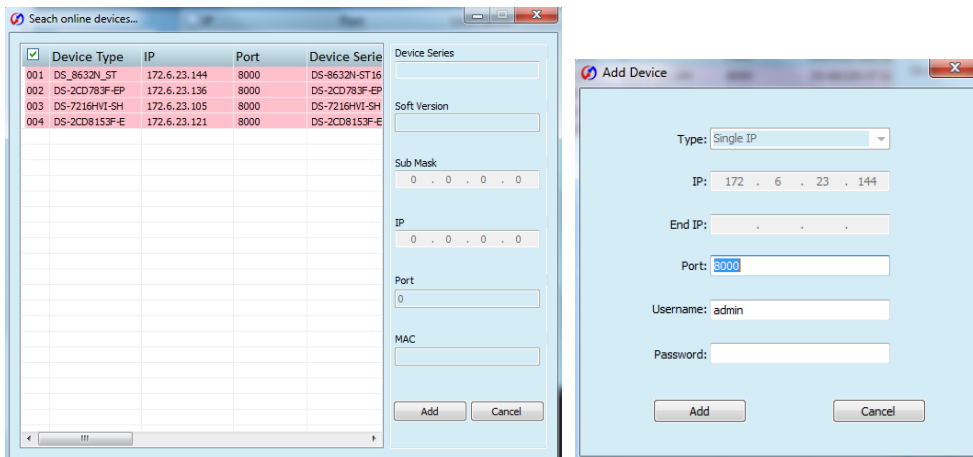

3. Enter the Username and Password for login.
4. Click **Add** to add the device.

The successfully added devices will be displayed on the list of **Device** interface.

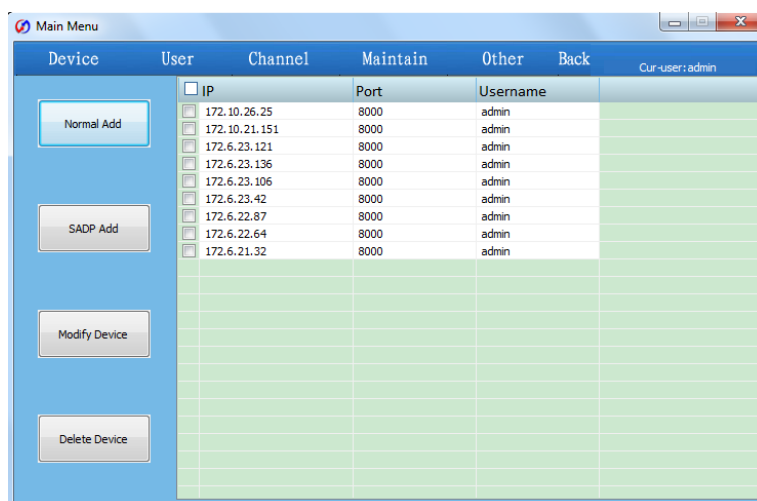

## Modifying a Device

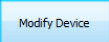
Select a device from the list, and click  to enter the Modify Device interface:

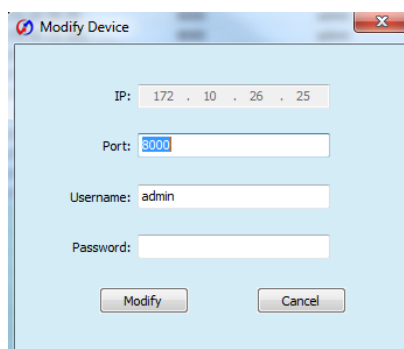

You are allowed to modify the port, login user name and password.

Click **Modify** to finish the modification.

## Deleting a Device

Select the device(s) from the list and click . The following message box pops up:

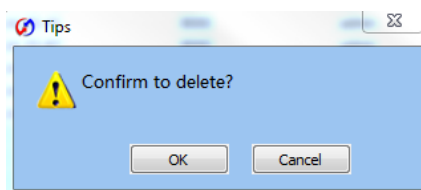

Click **OK** to confirm the deletion.

## 8.4.2 Managing User List

Click the **User** on the menu bar to enter the Device Management interface:

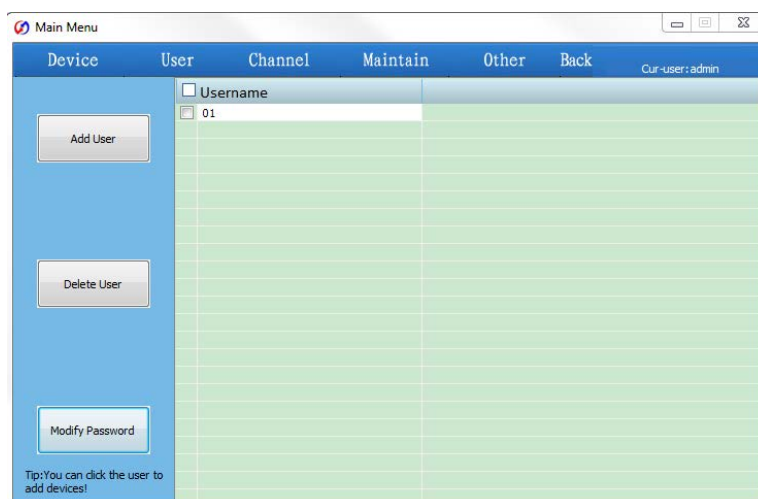

## Adding a User Account

1. Click  to enter the **Add User** interface.

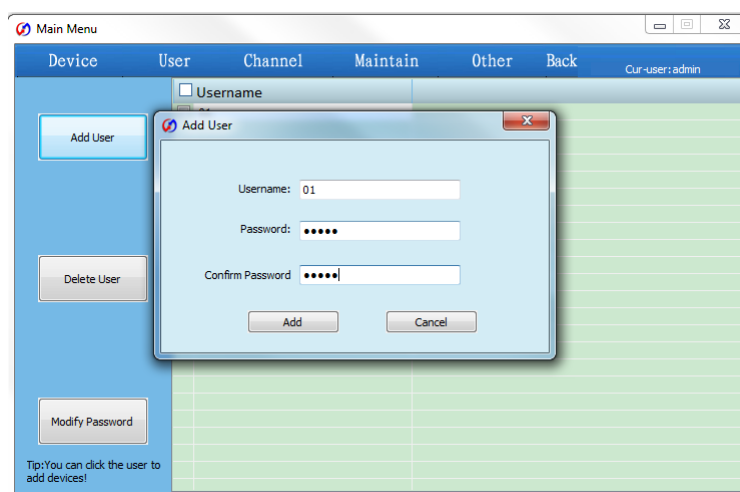

2. Enter the username and password.
3. Click **Add** to add the new user account.

The successfully added user accounts are listed on the interface:



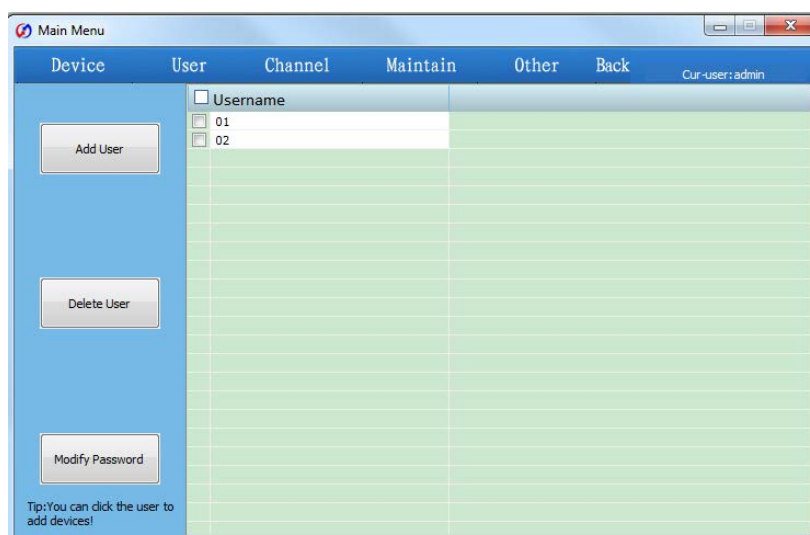

## Deleting a User Account

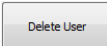
1. Select the user account(s) from the list, and click . The following message box pops up:

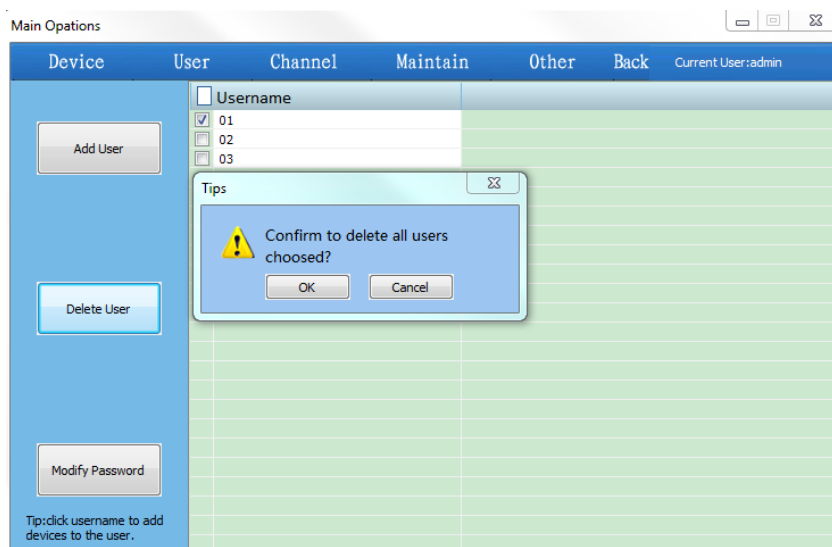

2. Click **OK** to confirm the deletion.

## Modifying Password

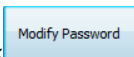
1. Select a user account from the list, and click  to enter the Modify Password interface:

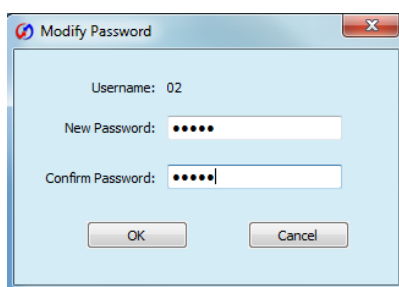

2. Enter the new password.
3. Click **OK** to finish the password modification.

### Adding the Device to User

1. Select a user account from the list and double-click it to enter the User Devices interface.
2. Select a device or multiple devices from the device list on the left and then click **Add>>**.

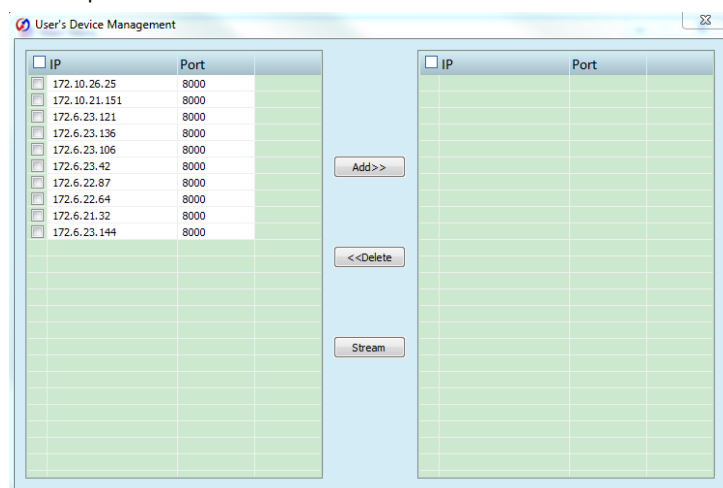

3. The device (s) successfully added for the current user will be displayed in the list on right.

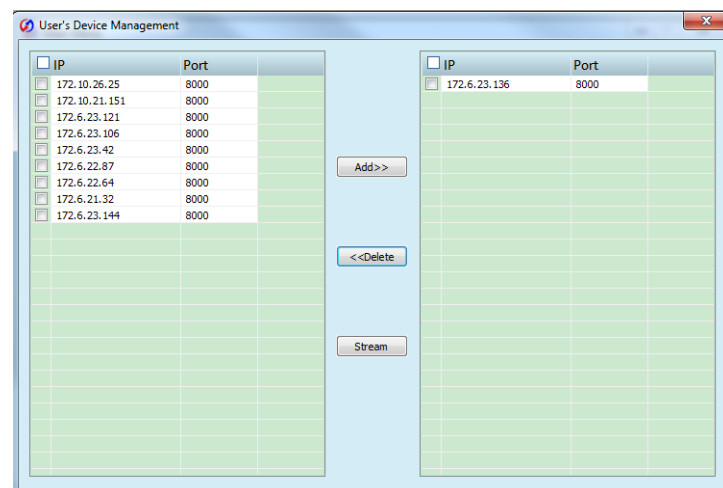

When you select multiple devices, the corresponding message box of the result will pop up:

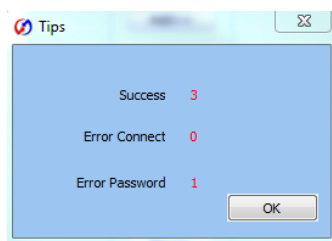

You can select the added device from the list on right and click  to delete it from the current user account.

## Adding Stream Media Server to Device

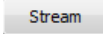
1. On the User Devices interface, select a decoder or multiple decoders from the list of added devices on right, and click  to enter the stream media server settings interface:

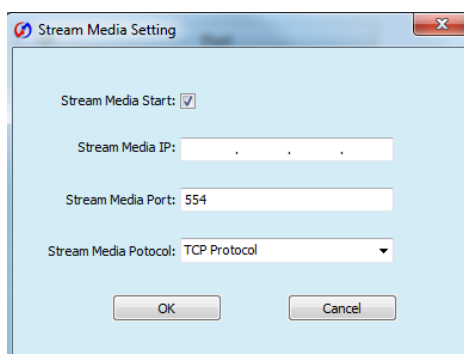

2. Check the checkbox of **Stream Media Start** to enable the stream.
3. Enter the Stream Media IP, Stream Media Port and the Stream Media Protocol (TCP/UDP).
4. Click **OK** to add the stream media server to the selected decoder(s).

**Note:** You can uncheck the checkbox of **Stream Media Start** and click **OK** to disable the stream media server for the device.

## 8.4.3 Managing Channel List

Click the **Channel** on the menu bar to enter the Channel Management interface:

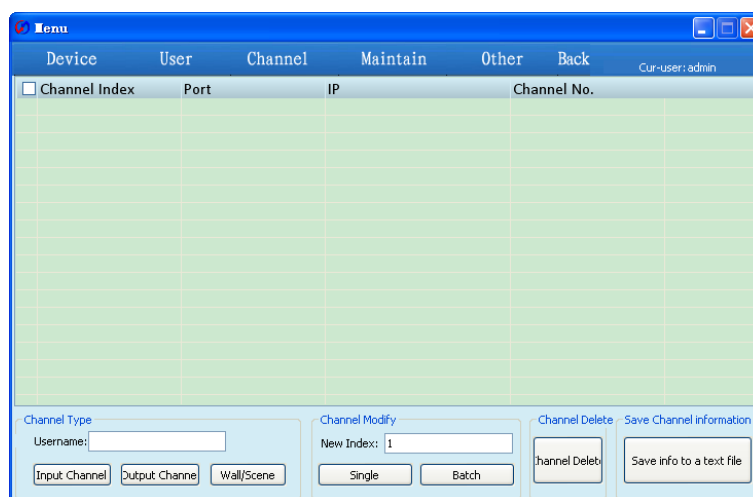

### Modifying Channel Index by Single

1. Enter the username of operator in the Channel Type field. Only the *operator* user account has the permission to operate channel management.
2. Click  ,  or  to get the channel list.

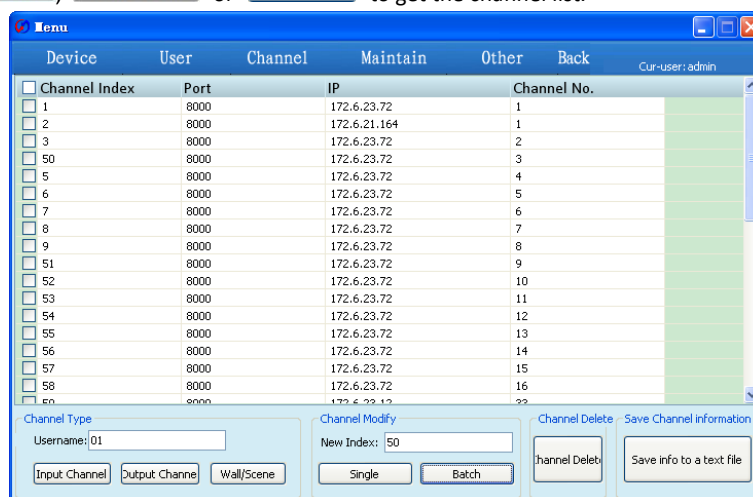

3. Select an item from the list, and enter the new index in the Channel Modify field.  
**Note:** The new index No. you enter must not exist in the channel list.
4. Click  to finish the channel index modification.

### Modifying Channel Index in Batch

1. Enter the username of operator in the Channel Type field. Only the *operator* user account has the permission to operate channel management.
2. Click  ,  or  to get the channel or scene list.

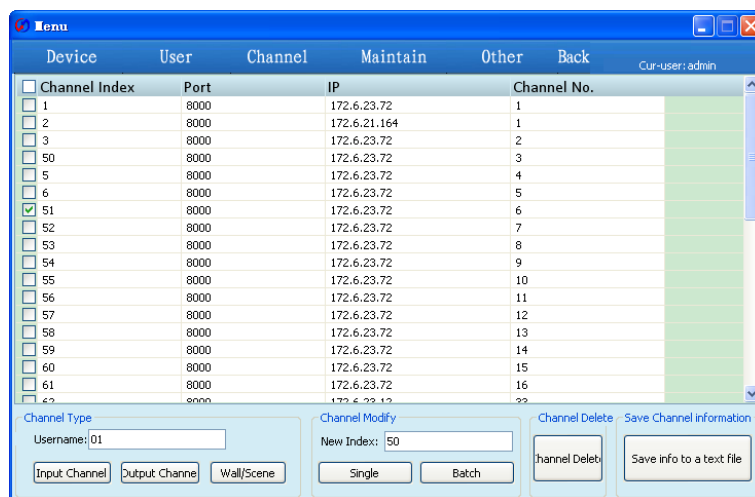

3. Select multiple items from the list, and enter the new index in the Channel Modify field.  
**Note:** The new index you enter refers to the starting index No. of the channel list.
4. Click  to finish the channel index modification.

### Deleting Channel(s)

1. Select the channel(s) from the list to be deleted.
2. Click  to delete the selected channel(s).

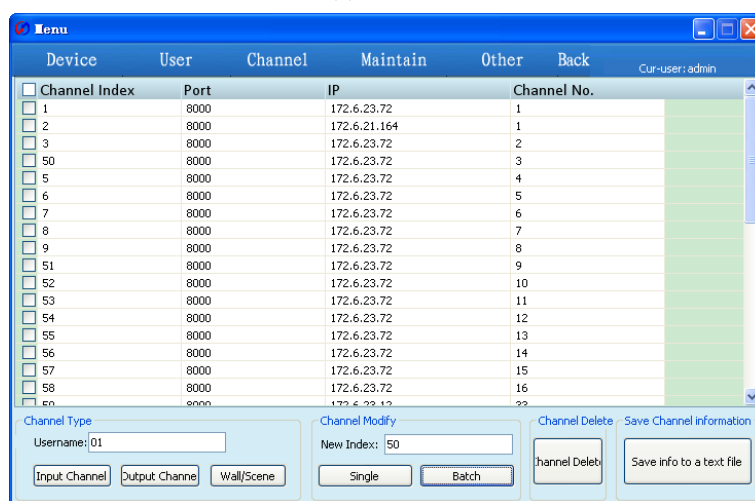

### Saving Channel(s)

1. On the Channel List interface, enter the username in the Channel Type field.
2. Click the  to save the channel information file (.txt) of the current login user to the directory where the configuration file is located.

## 8.4.4 Importing Configuration File

1. Click the **Maintain** on the menu bar to enter the Keyboard Maintenance interface.



The screenshot shows a web-based interface titled "Main Opations" with a navigation menu at the top containing "Device", "User", "Channel", "Maintain", "Other", and "Back". The "Current User: admin" is displayed on the right. The main content area is light blue and contains the following fields:

- Config file:
- Keyboard IP:
- Port:
- Username:  (Keyboard administrator)
- Password:

At the bottom center, there is an  button.

2. Select the directory of the keyboard configuration file.
3. Enter the IP address of the keyboard.
4. Enter the username and password.
5. Click  to import the configuration file to the keyboard.

The keyboard will restart after the configuration file has been imported.

## Appendix 1: Specifications

<b>Model</b>	<b>HBK-1100KI</b>	
<b>Control Mode</b>	IP-based	
<b>TFT LCD Panel</b>	7" TFT LCD monitor with touch panel	
	Resolution: 800 × 480	
<b>Joystick</b>	4-axis joystick	
<b>Audio Input / Output</b>	Line In	1-ch, 3.5 mm connector (2.0 Vp-p, 1 kΩ)
	Audio Out	1-ch, 3.5 mm connector (Linear, 560 Ω)
<b>External Interface</b>	Network Interface	1 10M/100M/1000M Ethernet interface
	RS-232 Interface	1 RS-232 interface
	RS-485 Interface	1 RS-485 interface
	USB Interface	1, USB2.0 (for data storage and device upgrade)
<b>General</b>	Power Supply	12V DC
	Power Consumption	≤ 15W
	Working Temperature	-10°C ~ +55°C
	Working Humidity	10% ~ 90%
	Dimensions (W × D × H)	435 × 193 × 110 mm
	Weight	2 Kg

## Appendix 2: Upgrade by FTP

Enable the FTP service on PC and operate the following steps:

**Steps:**

1. Open the wftp software, and then select Security->Users/rights option.



2. Create new user.

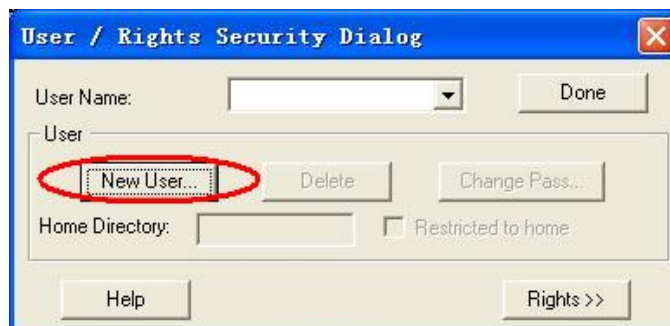

3. Input the user name: *target*, password: *target*, and then click **OK** to continue.



4. Select the user name to *target*.



5. Input the directory of the upgrade file in the text box of Home Directory, and then click **Done** to start system upgrading.